

NEWS 2023

lighting evolution

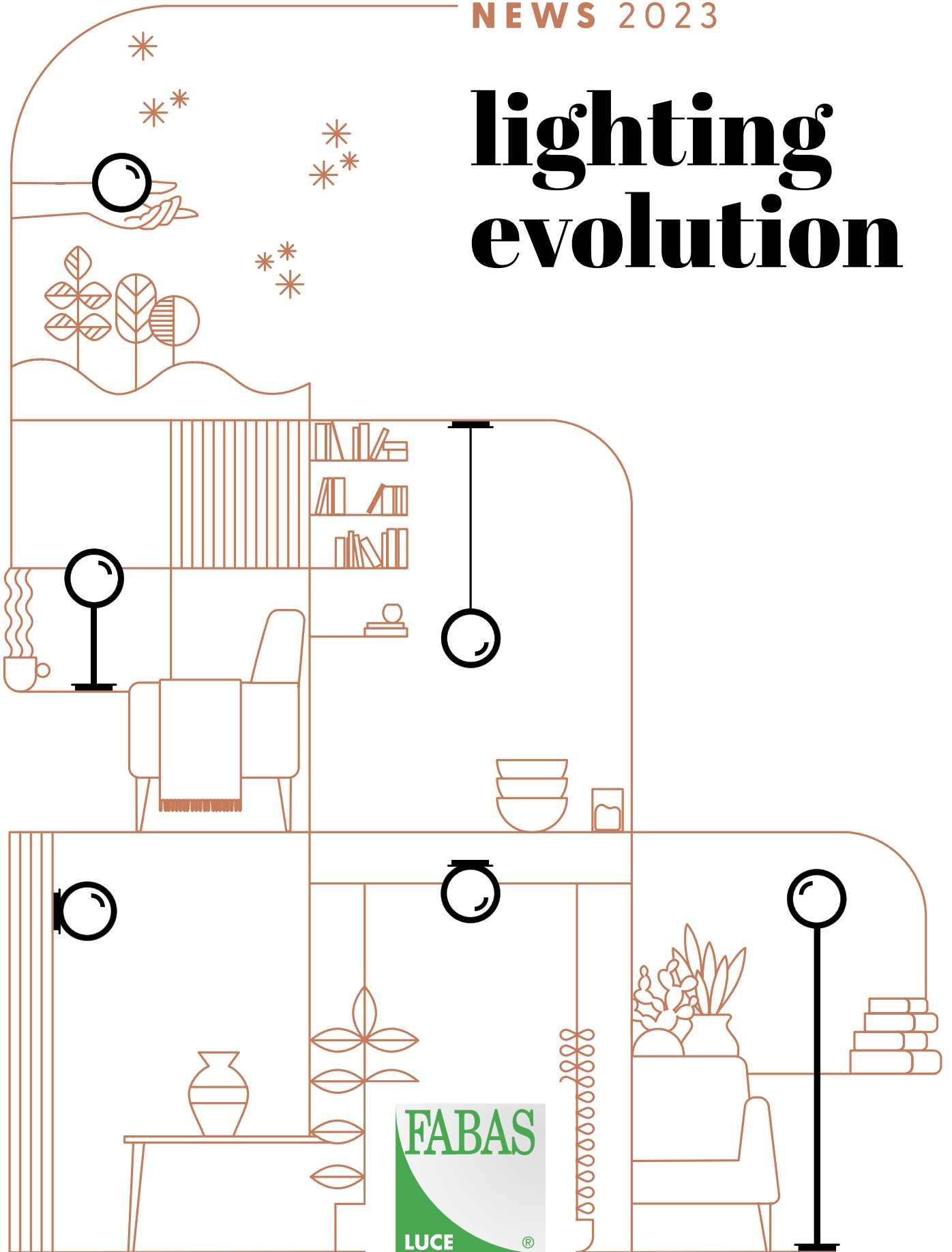

lighting evolution

NEWS 2023

Questo catalogo rappresenta la nostra continua dedizione nell'affrontare il cambiamento e anticipare le esigenze del domani. Troverete nuove soluzioni che testimoniano il **nostro impegno verso il miglioramento continuo e l'innovazione**, senza tralasciare creatività, funzionalità e ricerca.

This catalogue reflects our ongoing dedication to embracing change and anticipating future needs. Here, you will find new solutions showing **our unwavering commitment to continuous improvement and innovation**, but without neglecting creativity, functionality and research.



Innovation meets sustainability



Sempre attenti alla scelta di materiali naturali, oltre a legno, vetro, ceramica e tessuti, la gamma di prodotti si arricchisce della plastica vegetale PLA: per condividere la scelta sostenibile di Fabas, basta cercare il bollino PLA sul catalogo.

Consistently opting for natural materials, in addition to wood, glass, ceramic and fabrics, our product range is now enhanced with PLA plant-based plastic: to share the sustainable choice of Fabas, simply look for the PLA sticker in the catalogue.

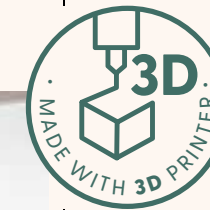

Carola, Cone, Lisa e Nadine:

le nostre lampade sostenibili realizzate in **stampa 3D**, uniscono forme eleganti e funzionalità, rispettando l'ambiente in quanto realizzate con **plastica vegetale PLA**.

Scegliendo le nuove lampade **PLA** contribuirete a promuovere un'economia circolare, riducendo la dipendenza dalle risorse non rinnovabili grazie a un design duraturo e più leggero per l'ambiente.

Carola, Cone, Lisa and Nadine:

our sustainable **3D-printed** lamps combine elegant shapes with functionality while respecting the environment, as they are made of **PLA plant-based plastic**.

By choosing our new **PLA** lamps, you will help to promote a **circular economy**, thus reducing dependence on non-renewable resources thanks to a long-lasting and more eco-friendly design.



L'innovazione incontra la sostenibilità

I vantaggi del PLA:

proviene da fonti rinnovabili dell'industria alimentare

è compostabile

capacità di degradarsi in modo naturale nel tempo

riduce l'impatto ambientale rispetto alla plastica tradizionale

progettato e prodotto in Italia

The advantages of PLA:

it comes from renewable sources in the food industry

it is compostable

it has the ability to degrade naturally over time

it reduces the environmental impact compared to traditional plastic

it is designed and manufactured in Italy

New look, new style!



Il catalogo presenta una nuova disposizione più funzionale: i prodotti sono presentati in base alla loro applicazione, con un rimando per il singolo articolo alle proposte complementari della stessa collezione.

Abbiamo lavorato per offrirvi un'esperienza visiva fresca e moderna, che si traduce in un nuovo modo di comunicare i nostri prodotti.

Ogni dettaglio è stato curato con attenzione per offrire una presentazione visiva coinvolgente e pratica.

We have striven to offer you a new and up-to-date visual experience, resulting in a **new approach to communicating our products.**

We have taken meticulous care of all details in order to provide an engaging and practical visual presentation.

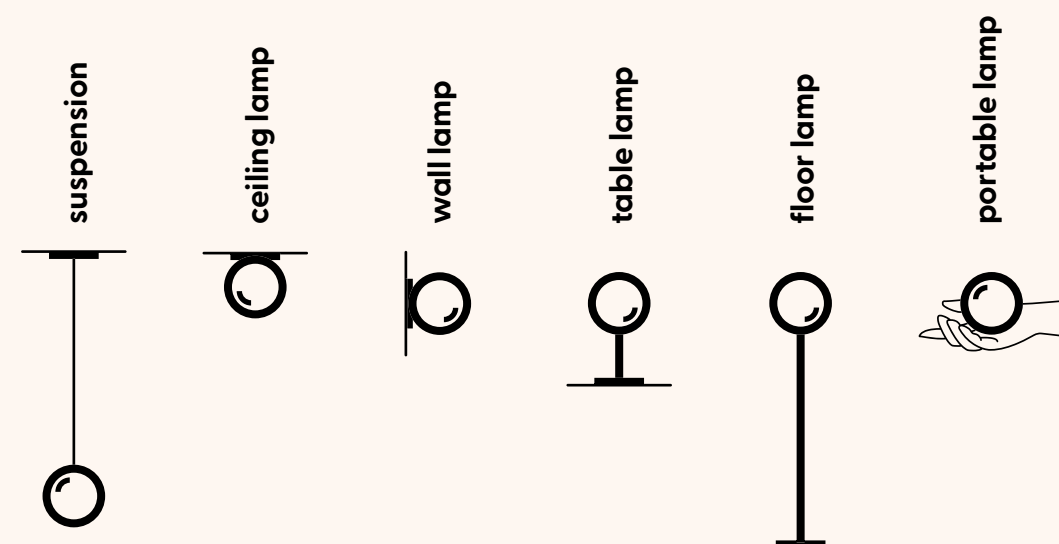

The catalogue has a new, more functional layout: products are presented according to their application, with each individual item linked to complementary products in the same collection.



Catalogue reading guide

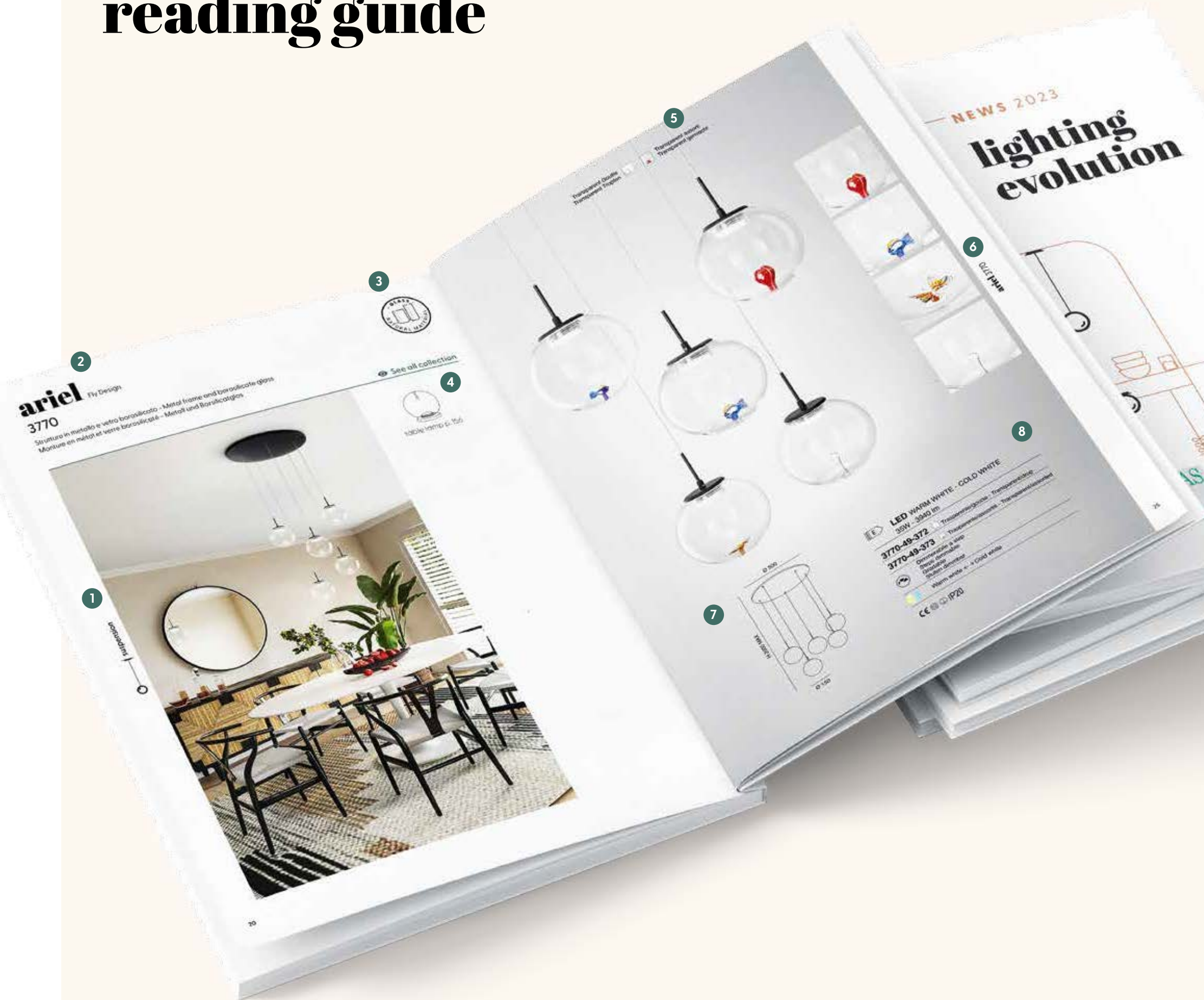

1 Capitolo di riferimento / Reference chapter / Chapitre de référence / Kapitel /

2 Nome collezione, codice di riferimento e descrizione materiali / Collection name, reference code and material description / Nom de la collection, code de référence et description du matériau / Name der Kollektion, Artikelreferenz und Materialbeschreibung

3 Icona con riferimento al materiale (vedi info a pag. 02) / Icon referring to the material (see info on page 02) / Icône faisant référence au matériau (voir info page 02) / Symbol zur Materialangabe (siehe Info auf Seite 02)

4 Qui trovi i rimandi ad articoli complementari per applicazione, ma della stessa collezione / Here you will find references to complementary items for application, but in the same collection / Vous trouverez ici des références d'articles complémentaires par application, mais de la même collection / Hier finden Sie Hinweise auf weitere Leuchtentypen innerhalb der jeweiligen Kollektion

5 Finiture colore / Color finishing / Finitions de couleur / Farbvarianten

6 Nome e codice collezione / Name and collection code / Nom et code de la collection / Name und Kollektion Nummer

7 Disegno tecnico con quote / Technical drawing with dimensions / Dessin technique avec cotes / Technische Zeichnung mit Maßangaben

8 Tabella con caratteristiche tecniche del prodotto e tutte le informazioni necessarie alla vendita e utilizzo. I vari simboli sono spiegati nelle pagine finali del catalogo / Technical characteristics table of the product and all information necessary for sale and use. The different symbols are explained in the last pages of the catalogue / Tableau avec les caractéristiques techniques du produit et toutes les informations nécessaires à la vente et à l'utilisation. Les différents symboles sont expliqués dans les pages finales du catalogue / Tabelle der technischen Angaben des Produktes und alle für den Verkauf und die Verwendung erforderlichen Informationen. Die verschiedenen Symbole werden auf den letzten Seiten des Katalogs erläutert

index suspension

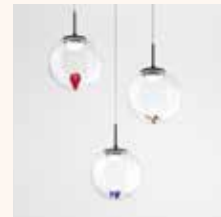

3770
ariel
PAGE 20



3394
bard
PAGE 70



3755
brena
PAGE 28



3757
carola
PAGE 14



3758
cone
PAGE 16



3774
deva
PAGE 50



3239
dunk
PAGE 66



KIT COMPONENTI
imagine your light
PAGE 76



3767
kino
PAGE 34



3768
lapo
PAGE 38



3481
lila
PAGE 42



3712
ling
PAGE 64



3759
lisa
PAGE 18



3750
loto
PAGE 58



3764
lucille
PAGE 54



3772
noa
PAGE 48



3743
palau
PAGE 60



3685
prado
PAGE 74

index ceiling lamp



3394
bard
PAGE 90



3767
kino
PAGE 88



3451
modo
PAGE 104



3709
relais
PAGE 100



3710
savoy
PAGE 102

index wall lamp



3720
ago
PAGE 136



3708
alide
PAGE 122



3618
banny
PAGE 112



3394
bard
PAGE 110



3717
dual
PAGE 128



3239
dunk
PAGE 116



3707
maribel
PAGE 120



3451
modo
PAGE 138



3361
nala
PAGE 130



3551
regina
PAGE 124



3715
roseg
PAGE 126

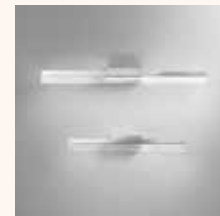

3719
sinis
PAGE 134



3682
viki
PAGE 118

visual index

index
table
lamp



3770
ariel
PAGE 156



3394
bard
PAGE 164



3775
beba
PAGE 166



3761
elea
PAGE 160



3752
freddy
PAGE 152



3703
ibla
PAGE 162



3550
ideal
PAGE 170



3754
micky
PAGE 158



3760
nadine
PAGE 146



3551
regina
PAGE 168



3783
victoria
PAGE 154



3762
wendy
PAGE 148



3763
wilma
PAGE 150

index
floor
lamp



3775
beba
PAGE 176



3550
ideal
PAGE 178



3712
ling
PAGE 188



3750
loto
PAGE 174



3551
regina
PAGE 182

index
portable
lamp

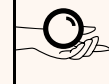

3742
armanda
PAGE 192



3738
blend
PAGE 196

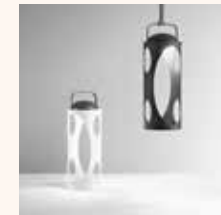

3740
caddy
PAGE 200



3741
clamp
PAGE 198





Blanc - Weiss Bordeaux
 Couleur moutard - Senffarbe

3757

Struttura in metallo e plastica vegetale - Metal frame and bio-based plastic
 Monture en métal et plastique végétal - Metall und biobasierter Kunststoff



suspension



carola 3757

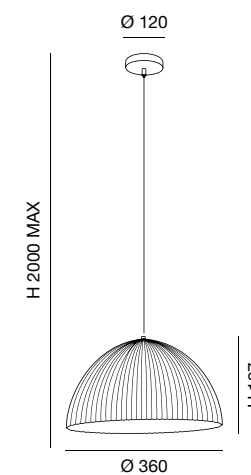

E27
1x10W

3757-40-102 Bianco - White

3757-40-133 Bordeaux - Burgundy

3757-40-367 Senape - Mustard colored





CE IP20

cone Design s.t. Fabas Luce

3758

Struttura in metallo e plastica vegetale - Metal frame and bio-based plastic
Monture en métal et plastique végétal - Metall und biobasierter Kunststoff



Blanc - Weiss   Bordeaux
Orange   Couleur moutard - Senffarbe

suspension

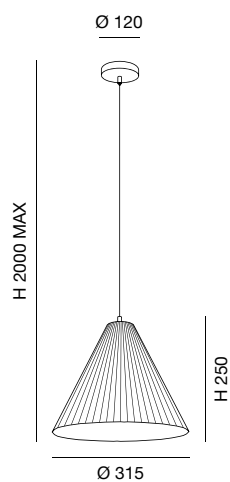

E27

1x10W

3758-40-102  Bianco - White

3758-40-133  Bordeaux - Burgundy

3758-40-170  Arancio - Orange

3758-40-367  Senape - Mustard colored

CE   IP20

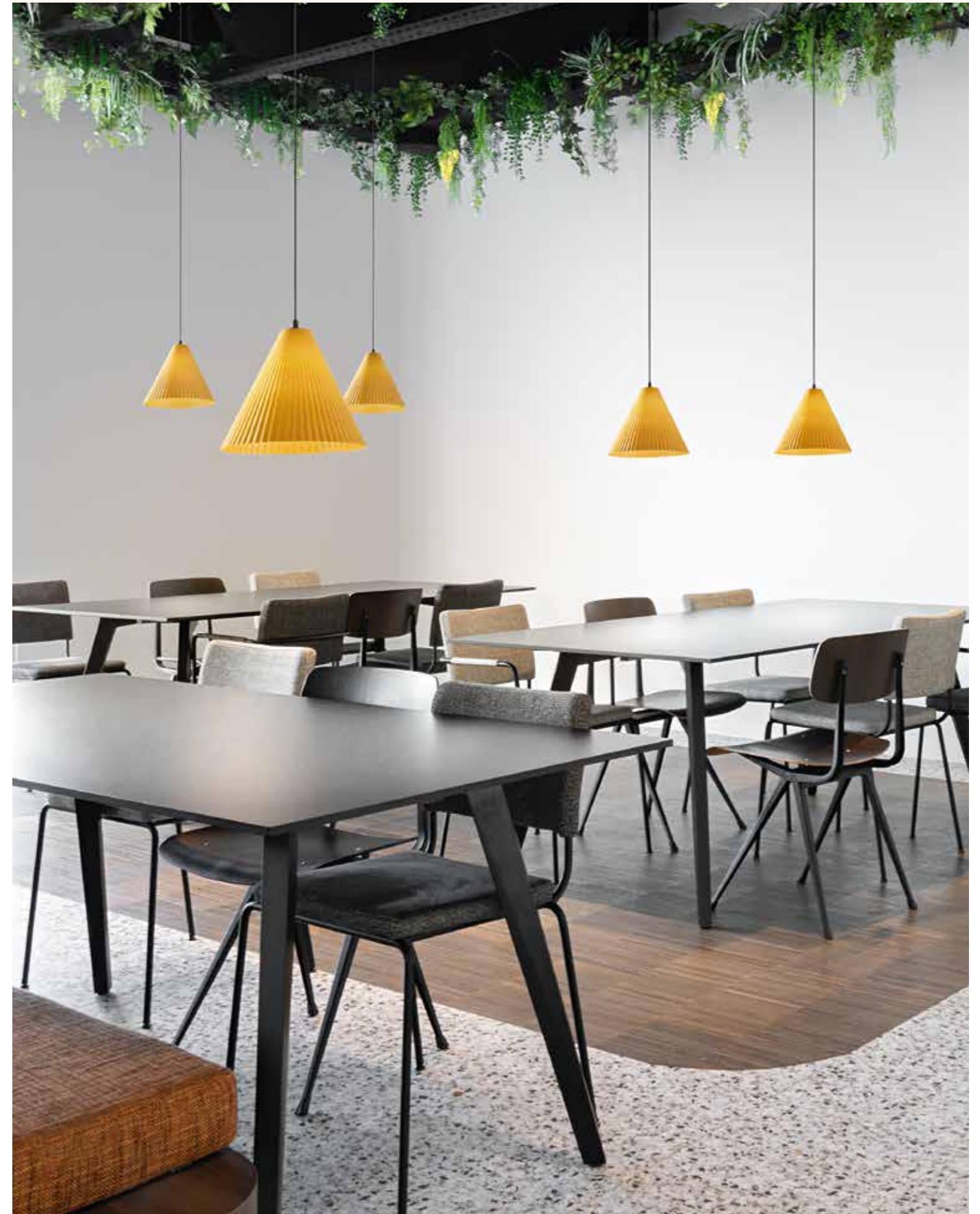

cone 3758

Struttura in metallo e plastica vegetale - Metal frame and bio-based plastic
 Monture en métal et plastique végétal - Metall und biobasierter Kunststoff



Blanc - Weiss Bordeaux
 Couleur moutard - Senffarbe



suspension



lisa 3759

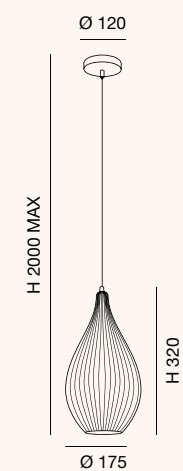

E27
1x10W

3759-40-102 Bianco - White

3759-40-133 Bordeaux - Burgundy

3759-40-367 Senape - Mustard colored

CE \otimes \oplus IP20



See all collection

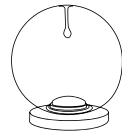
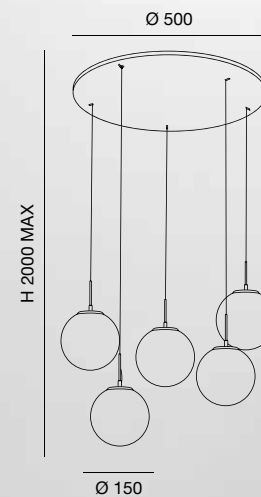
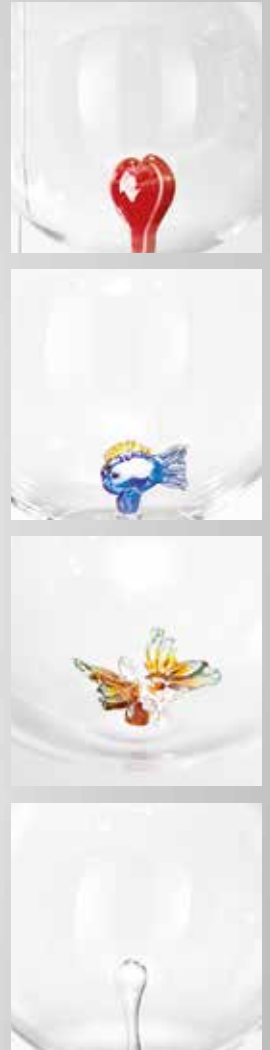

table lamp p. 156



suspension



E LED WARM WHITE - NATURAL WHITE
 35W - 3750 lm

3770-49-372 Traspirente/goccia - Transparent/drop

3770-49-373 Traspirente/assortiti - Transparent/assorted

Dimmerabile a step
 Steps dimmable
 Gradable
 In Stufen dimmbar

Warm white ↔ Natural white

CE IP20

Transparent goutte
Transparent Tropfen



Transparent assorti
Transparent gemischt

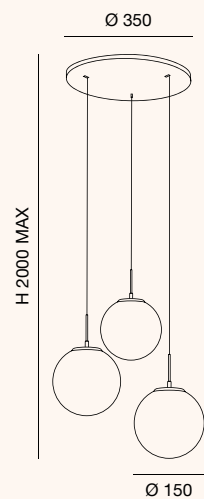

LED WARM WHITE - NATURAL WHITE
21W - 2250 lm

3770-47-372 Trasparente/goccia - Transparent/drop

3770-47-373 Trasparente/assortiti - Transparent/assorted

Dimmerabile a step
Steps dimmable
Gradable
In Stufen dimmbar

Warm white ← → Natural white

CE IP20



Transparent goutte
Transparent Tropfen



LED WARM WHITE - NATURAL WHITE
8W - 750 lm

3770-40-372 Trasparente/goccia - Transparent/drop

Dimmerabile a step
Steps dimmable
Gradable
In Stufen dimmbar

Warm white ↔ Natural white

CE IP20

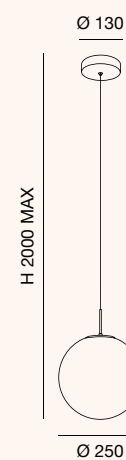

LED WARM WHITE - NATURAL WHITE
14W - 1510 lm

3770-45-372 Trasparente/goccia - Transparent/drop

Dimmerabile a step
Steps dimmable
Gradable
In Stufen dimmbar

Warm white ↔ Natural white

CE IP20



Transparent goutte
Transparent Tropfen

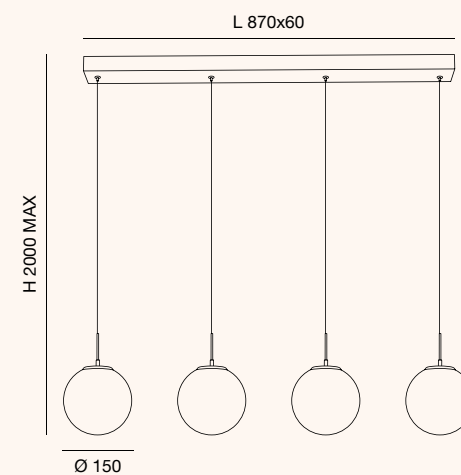

E LED WARM WHITE - NATURAL WHITE
28W - 3000 lm

3770-48-372 Traspirente/goccia - Transparent/drop

Dimmerabile a step
Steps dimmable
Gradable
In Stufen dimmbar

Warm white ↔ Natural white

CE IP20



Transparent   Cognac

suspension



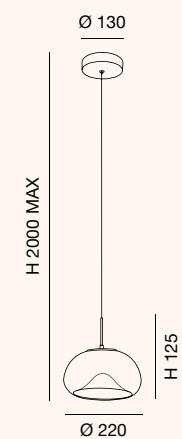

brena 3755



E LED WARM WHITE - NATURAL WHITE
 10W - 1080 lm

3755-41-241  Trasparente - Transparent

3755-41-365  Cognac

 Dimmerabile a step
 Steps dimmable
 Gradable
 In Stufen dimmbar

 Warm white ↔ Natural white

CE   IP20

Transparent   Cognac

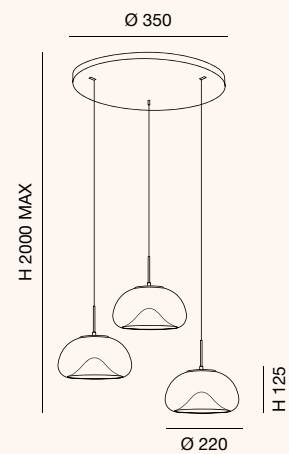

LED WARM WHITE - NATURAL WHITE
30W - 3240 lm

3755-47-241  Trasparente - Transparent

3755-47-365  Cognac

 Dimmerabile a step
Steps dimmable
Gradable
In Stufen dimmbar

 Warm white \leftrightarrow Natural white

CE   IP20

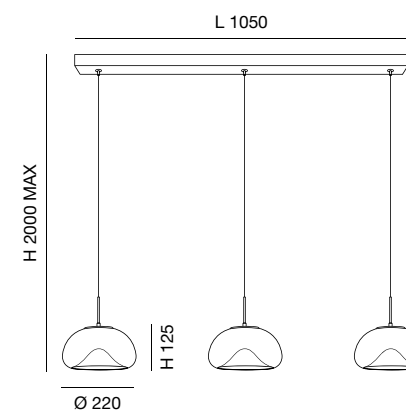

LED WARM WHITE - NATURAL WHITE
30W - 3240 lm

3755-48-241  Trasparente - Transparent

3755-48-365  Cognac

 Dimmerabile a step
Steps dimmable
Gradable
In Stufen dimmbar

 Warm white \leftrightarrow Natural white

CE   IP20



Transparent   Cognac

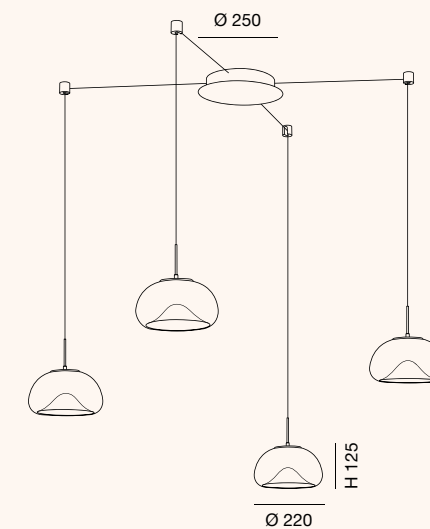

LED WARM WHITE - NATURAL WHITE
40W - 4320 lm

3755-49-241  Trasparente - Transparent

3755-49-365  Cognac

 Dimmerabile a step
Steps dimmable
Gradable
In Stufen dimmbar

 Warm white ↔ Natural white

Lunghezza di ogni cavo 3500 mm
Length of each cable 3500 mm
Longueur de chaque cable 3500 mm
Kabellänge je 3500 mm

CE   IP20

3767

Struttura in metallo e vetro borosilicato - Metal frame and borosilicate glass
 Monture en métal et verre borosilicaté - Metall und Borsilicatglas



[See all collection](#)

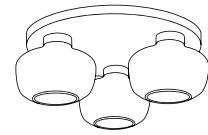

ceiling lamp p. 88

suspension



Blanc - Weiß Cognac

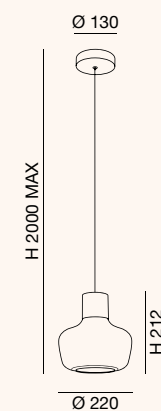

LED WARM WHITE
 12W - 1300 lm

3767-40-102 Bianco - White

3767-40-365 Cognac

Dimmerabile a step
 Steps dimmable
 Gradable
 In Stufen dimmbar

CE IP20



Blanc - Weiß Cognac

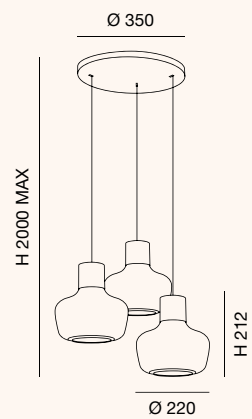

LED WARM WHITE
36W - 3900 lm

3767-47-102 Bianco - White

3767-47-365 Cognac

Dimmerabile a step
Steps dimmable
Gradable
In Stufen dimmbar

CE IP20

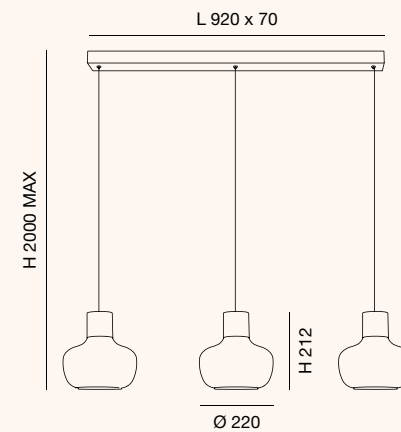

LED WARM WHITE
36W - 3900 lm

3767-48-102 Bianco - White

3767-48-365 Cognac

Dimmerabile a step
Steps dimmable
Gradable
In Stufen dimmbar

CE IP20

lapo Design by Ilaria Marelli
3768

Struttura in metallo e vetro borosilicato - Metal frame and borosilicate glass
Monture en métal et verre borosilicaté - Metall und Borsilicatglas



suspension



Cognac

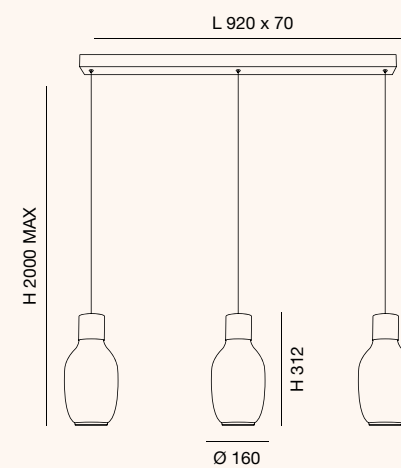

E LED WARM WHITE
36W - 3900 lm

3768-48-365 Cognac

Dimmerabile a step
Steps dimmable
Gradable
In Stufen dimmbar

CE IP20

Cognac



suspension

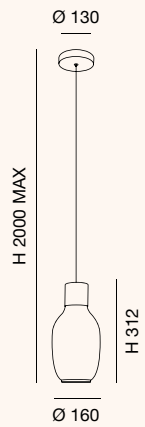

LED WARM WHITE
12W - 1300 lm

3768-40-365 Cognac

Dimmerabile a step
Steps dimmable
Gradable
In Stufen dimmbar

CE IP20



lapo 3768

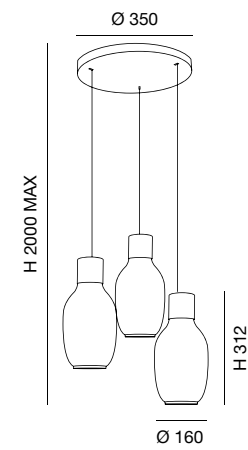

LED WARM WHITE
36W - 3900 lm

3768-47-365 Cognac

Dimmerabile a step
Steps dimmable
Gradable
In Stufen dimmbar

CE IP20

3481

Struttura in metallo e vetro borosilicato - Metal frame and borosilicate glass
 Monture en métal et verre borosilicaté - Metall und Borsilicatglas



- Ambre - Amber Gris transparent - Grau transparent
- Vert transparent - Transparent grün Transparent - Transparent
- Bleu ciel - Azurblau



suspension

lila 3481

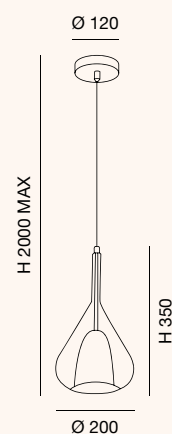

E27

1x40W

3481-40-125 Ambra - Amber

3481-40-126 Fumé - Transparent grey

3481-40-140 Verde trasparente
Transparent green

3481-40-241 Trasparente - Transparent

3481-40-244 Azzurro trasparente
Light blue







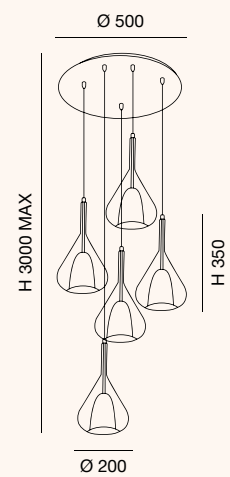

CE IP20

Ambre - Amber   Gris transparent - Grau transparent
 Vert transparent - Transparent grün   Transparent - Transparent
 Bleu ciel - Azurblau 







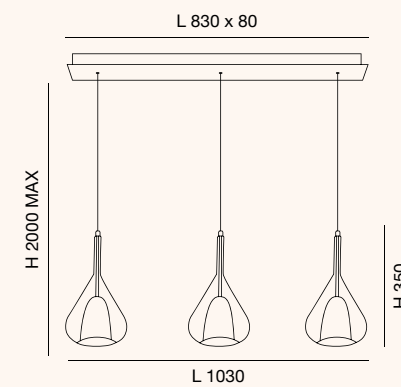

Ambre - Amber   Gris transparent - Grau transparent
 Transparent - Transparent 



E27
 5x40W
3481-49-362     
 Ambra, Fumé, Verde trasparente, Trasparente, Azzurro
 Amber, Transparent grey, Transparent green,
 Transparent, Light blue
 CE    IP20







E27
 3x40W
3481-48-297   
 Ambra, Fumé, Trasparente
 Amber, Transparent grey, Transparent

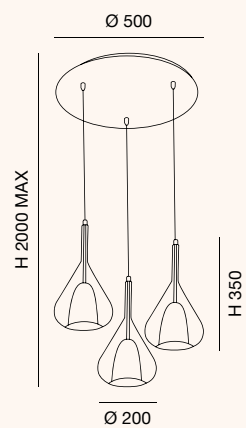

CE    IP20

 Compatible - Compatible - Kompatibel
 [Pagina - Page - Seite 207]

Ambre - Amber   Gris transparent - Grau transparent
Transparent - Transparent 



E27
3x40W
3481-47-297   
Ambra, Fumé, Trasparente
Amber, Transparent grey, Transparent

CE   IP20





- Ambre - Amber Gris transparent - Grau transparent
- Transparent - Transparent

suspension



noa 3772

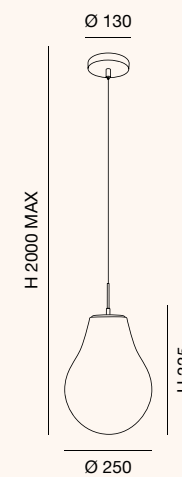

E LED WARM WHITE - NATURAL WHITE
 14W - 1510 lm

3772-40-125 Ambra - Amber

3772-40-126 Fumé - Transparent grey

3772-40-241 Trasparente - Transparent

Dimmerabile a step
 Steps dimmable
 Gradable
 In Stufen dimmbar

Warm white ↔ Natural white

CE IP20



Ambre - Amber   Gris transparent - Grau transparent
 Transparent - Transparent 

suspension



deva 3774

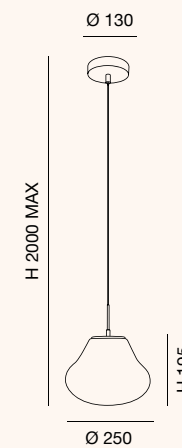



LED WARM WHITE - NATURAL WHITE
 14W - 1510 lm

3774-40-125  Ambra - Amber

3774-40-126  Fumé - Transparent grey

3774-40-241  Trasparente - Transparent

 Dimmerabile a step
 Steps dimmable
 Gradable
 In Stufen dimmbar

 Warm white ↔ Natural white

CE   IP20

Ambre - Amber  Gris transparent - Grau transparent 
 Transparent - Transparent 

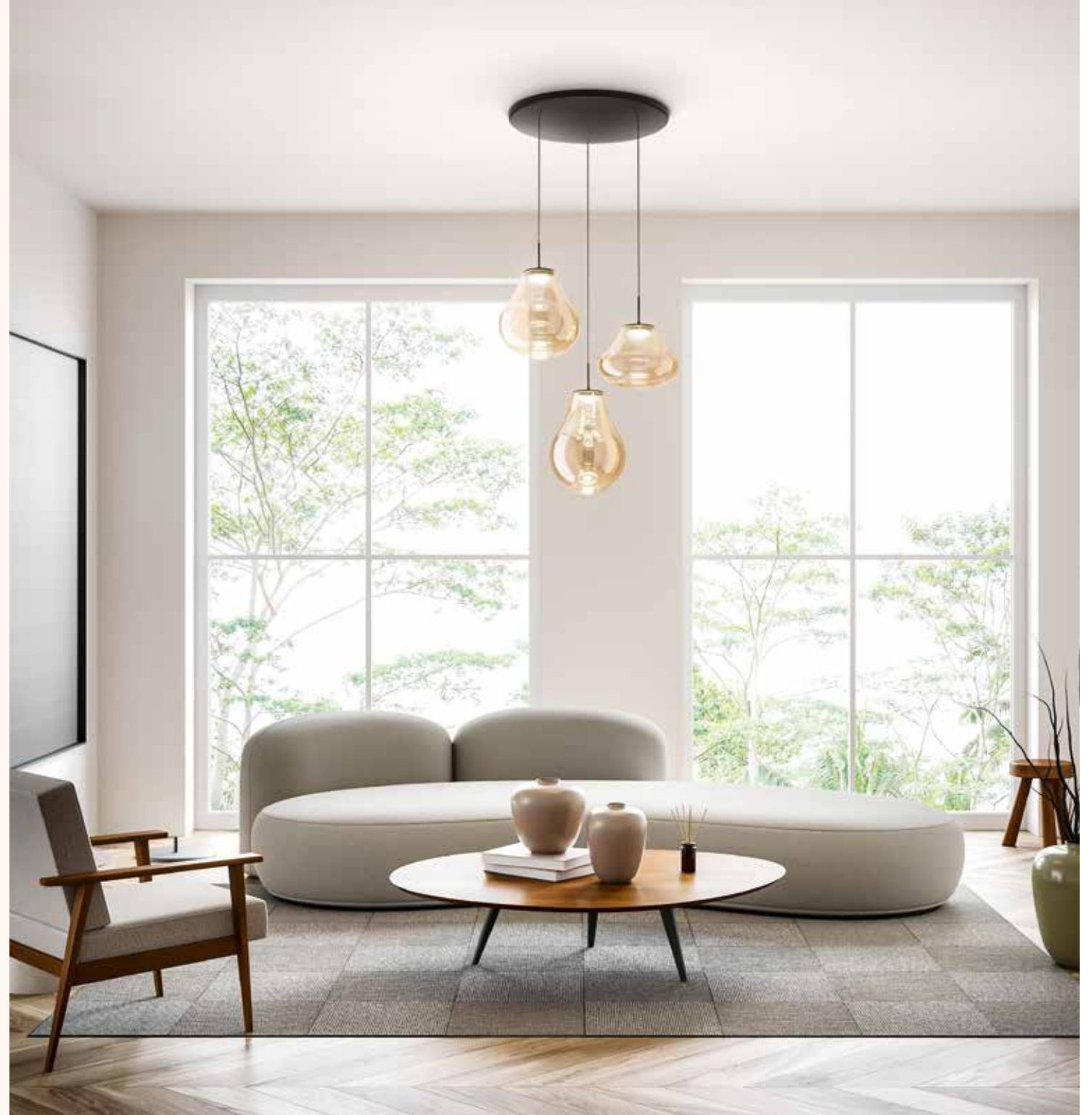



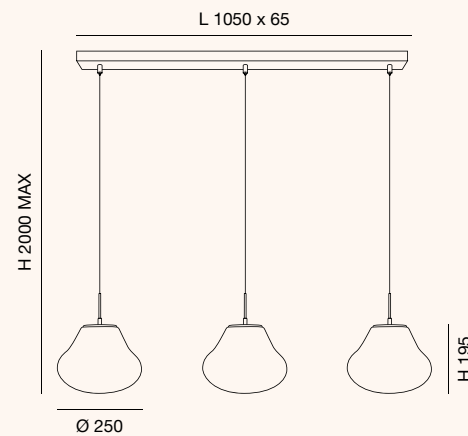

suspension

deva 3774



LED WARM WHITE - NATURAL WHITE
 42W - 4530 lm

- 3774-48-125**  Ambra - Amber
- 3774-48-126**  Fumé - Transparent grey
- 3774-48-241**  Trasparente - Transparent



 Dimmerabile a step
 Steps dimmable
 Gradable
 In Stufen dimmbar

 Warm white ↔ Natural white

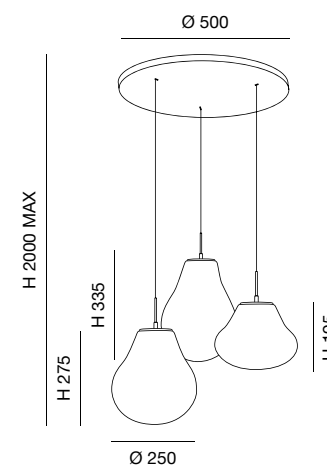
CE   IP20



LED WARM WHITE - NATURAL WHITE
 42W - 4530 lm

- 3774-47-125**  Ambra - Amber
- 3774-47-126**  Fumé - Transparent grey
- 3774-47-241**  Trasparente - Transparent

 Dimmerabile a step
 Steps dimmable
 Gradable
 In Stufen dimmbar



 Warm white ↔ Natural white

CE   IP20

3764

Struttura in metallo e vetro borosilicato - Metal frame and borosilicate glass
 Monture en métal et verre borosilicaté - Metall und Borsilicatglas



Gris transparent - Grau transparent   Cognac

suspension



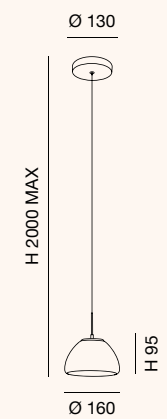

Lucille 3764



LED WARM WHITE - NATURAL WHITE
 8W - 750 lm



3764-41-126  Fumè - Transparent grey

3764-41-365  Cognac

 Dimmerabile a step
 Steps dimmable
 Gradable
 In Stufen dimmbar

 Warm white ↔ Natural white

CE   IP20

Gris transparent - Grau transparent   Cognac

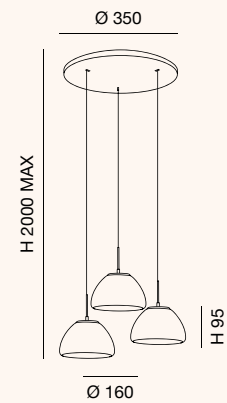

 **LED WARM WHITE - NATURAL WHITE**
21W - 2250 lm

3764-47-126  Fumè - Transparent grey

3764-47-365  Cognac

 Dimmerabile a step
Steps dimmable
Gradable
In Stufen dimmbar

 Warm white ← → Natural white

CE   IP20

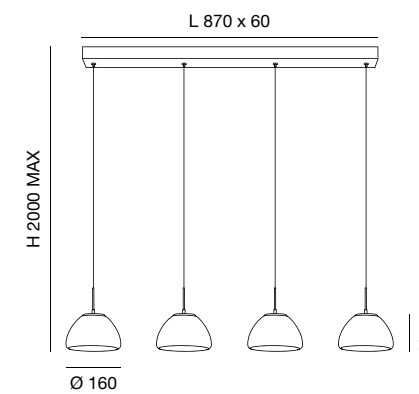

 **LED WARM WHITE - NATURAL WHITE**
28W - 3000 lm

3764-48-126  Fumè - Transparent grey

3764-48-365  Cognac

 Dimmerabile a step
Steps dimmable
Gradable
In Stufen dimmbar

 Warm white ← → Natural white

CE   IP20



[See all collection](#)

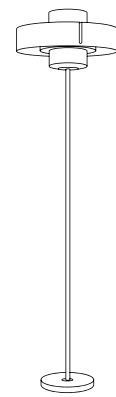

floor lamp p. 174

suspension

- Anthracite - Anthrazit
- Sable - Sandfarbe
- Brique - Ziegelfarbe



loto 3750

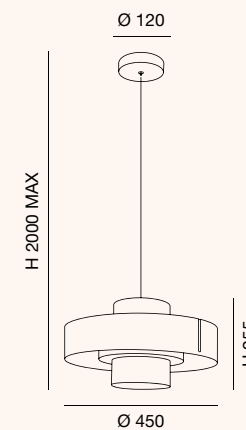

E27
1x40W

3750-40-282 Anthracite - Anthracite

3750-40-355 Sabbia - Sand

3750-40-358 Mattone - Bricky

CE IP20

palau

Design s.t. Fabas Luce

3743

Struttura in metallo e metacrilato - Metal and methacrylate frame
 Monture en métal et métachrylate - Metall und Methacrylat



suspension

Blanc - Weiss Or mat - Gold edelmatt

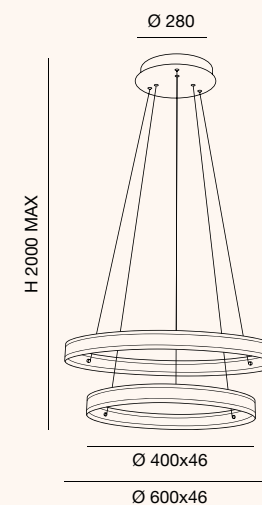

LED WARM WHITE
 108W - 11780 lm

3743-45-102 Bianco - White

3743-45-225 Oro opaco - Gold matt

 LED dimmerabile a taglio di fase
 Phase cut dimmable LED
 LED dimmable à découpage de phase
 LED dimmbar (über Phasen- und abschnittdimmer)

CE   IP20

palau 3743

Blanc - Weiss   Or mat - Gold edelmatt

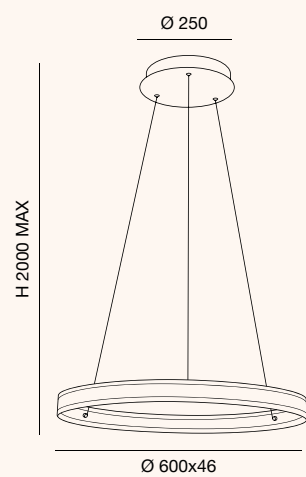

 **LED WARM WHITE**
60W - 6540 lm

3743-40-102  Bianco - White

3743-40-225  Oro opaco - Gold matt

 LED dimmerabile a taglio di fase
Phase cut dimmable LED
LED dimmable à découpage de phase
LED dimmbar (über Phasen- und abschnittdimmer)

 Compatibile - Compatible - Kompatibel
[Pagina - Page - Seite 207]

CE    IP20

Blanc - Weiss   Or mat - Gold edelmatt

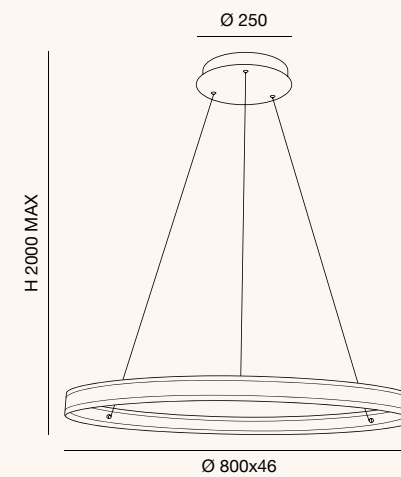

 **LED WARM WHITE**
64W - 6980 lm

3743-46-102  Bianco - White

3743-46-225  Oro opaco - Gold matt

 LED dimmerabile a taglio di fase
Phase cut dimmable LED
LED dimmable à découpage de phase
LED dimmbar (über Phasen- und abschnittdimmer)

 Compatibile - Compatible - Kompatibel
[Pagina - Page - Seite 207]

CE    IP20

3712

Struttura in metallo e metacrilato - Metal and methacrylate frame
 Monture en métal et métachrylate - Metall und Methacrylat

Noir - Schwarz  Laiton satiné - Messing satiniert 

[See all collection](#)

suspension



floor lamp p. 188

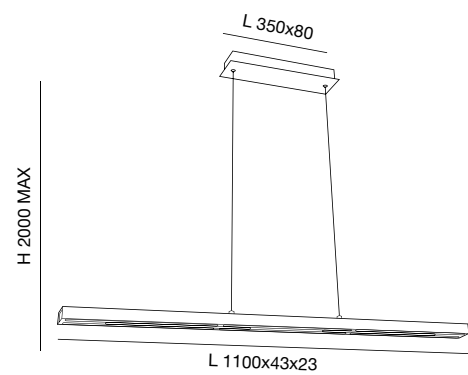

 **LED WARM WHITE**
 40W - 4800 lm

3712-45-101  Nero - Black

3712-45-119  Ottone satinato
 Satined brass

Regolazione luce con pulsante
 Push dimmer
 Bouton poussoir dimmable
 Tastdimmer

CE   IP20



ling 3712

3239

Struttura in metallo e metacrilato - Metal and methacrylate frame
 Monture en métal et métachrylate - Metall und Methacrylat

See all collection

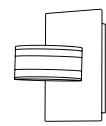

wall lamp p. 116

suspension

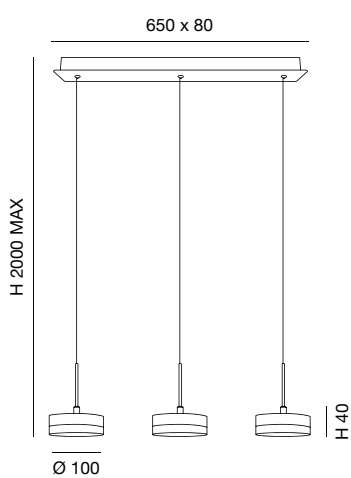

LED WARM WHITE
 24W - 2260 lm

3239-47-119 ■ Ottone satinato
 Satined brass

3239-47-212 ■ Alluminio spazzolato
 Brushed aluminum

LED dimmerabile a taglio di fase
 Phase cut dimmable LED
 LED dimmable à découpage de phase
 LED dimmbar (über Phasen- und
 abschnittdimmer)

Compatibile - Compatible - Kompatibel
 [Pagina - Page - Seite 207]

CE IP20

Laiton satiné - Messing satiniert ■ Aluminium brossé - Aluminium gebürstet

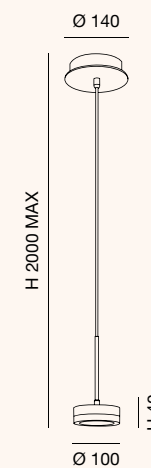

LED WARM WHITE
 8W - 750 lm

3239-40-119 ■ Ottone satinato
 Satined brass

3239-40-212 ■ Alluminio spazzolato
 Brushed aluminum

Compatibile - Compatible - Kompatibel
 [Pagina - Page - Seite 207]

CE IP20

Laiton satiné - Messing satiniert   Aluminium brossé - Aluminium gebürstet



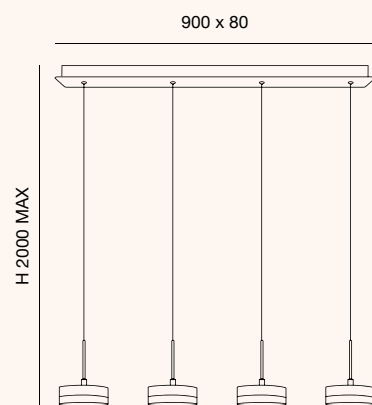

suspension

dunk 3239



 **LED WARM WHITE**
32W - 3020 lm

3239-49-119  Ottone satinato
Satined brass

3239-49-212  Alluminio spazzolato
Brushed aluminum

 LED dimmerabile a taglio di fase
Phase cut dimmable LED
LED dimmable à découpage de phase
LED dimmbar (über Phasen- und abschnittdimmer)

 Compatibile - Compatible - Kompatibel
[Pagina - Page - Seite 207]

CE   IP20

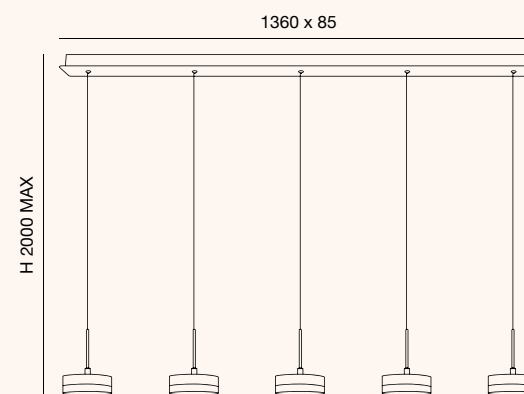

 **LED WARM WHITE**
40W - 3780 lm

3239-48-119  Ottone satinato
Satined brass

3239-48-212  Alluminio spazzolato
Brushed aluminum

 LED dimmerabile a taglio di fase
Phase cut dimmable LED
LED dimmable à découpage de phase
LED dimmbar (über Phasen- und abschnittdimmer)

 Compatibile - Compatible - Kompatibel
[Pagina - Page - Seite 207]

CE   IP20

3394

Struttura in metallo e metacrilato - Metal and methacrylate frame
Monture en métal et métachrylate - Metall und Methacrylat

[See all collection](#)

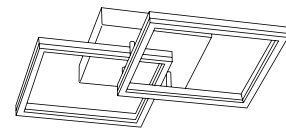

ceiling lamp p. 90

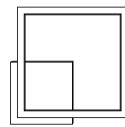

wall lamp p. 110

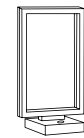

table lamp p. 164



suspension

- Noir - Schwarz Blanc - Weiss
- Or mat - Gold edelmatt Anthracite - Anthrazit
- Corten - Rostbraun



bard 3394

LED NATURAL WHITE
52W - 5400 lm

3394-43-102 Bianco - White

3394-43-282 Antracite - Anthracite

LED dimmerabile a taglio di fase
Phase cut dimmable LED
LED dimmable à découpage de phase
LED dimmbar (über Phasen- und abschnittdimmer)

CE

LED WARM WHITE
52W - 5180 lm

3394-45-101 Nero - Black

3394-45-102 Bianco - White

3394-45-225 Oro opaco - Gold matt

3394-45-282 Antracite - Anthracite

3394-45-361 Corten - Rostbraun

LED dimmerabile a taglio di fase
Phase cut dimmable LED
LED dimmable à découpage de phase
LED dimmbar (über Phasen- und abschnittdimmer)

CE

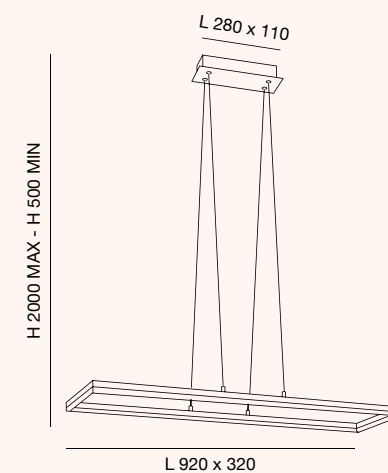



Noir - Schwarz Or mat - Gold edelmatt
 Anthracite - Anthrazit

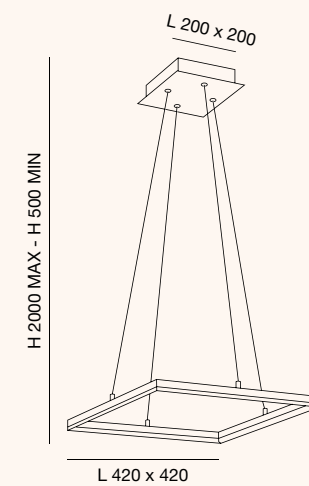

LED WARM WHITE
 39W - 3880 lm

3394-40-102 Bianco - White

3394-40-225 Oro opaco - Gold matt

3394-40-282 Antracite - Anthracite

LED dimmerabile a taglio di fase
 Phase cut dimmable LED
 LED dimmable à découpage de phase
 LED dimmbar (über Phasen- und abschnittdimmer)

Integrato - Integrated - Intégré - Integriert
 [Pagina - Page - Seite 207]

CE IP20

prado



Design s.t. Fabas Luce

3685

Struttura in metallo e metacrilato - Metal and methacrylate frame
 Monture en métal et métachrylate - Metall und Methacrylat



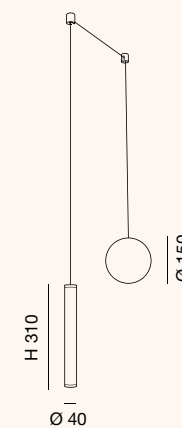

suspension

Noir - Schwarz   Blanc - Weiss
 Noir/Laiton satiné - Schwarz/Messing satiniert 



 **LED WARM WHITE**
 6.5W - 720 lm

3685-41-101  Nero - Black

3685-41-102  Bianco - White

3685-41-209  Nero / Ottone satinato
 Black / Satined brass

 Dimmerabile a step
 Steps dimmable
 Gradable
 In Stufen dimmbar

Lunghezza cavo 5000 mm
 Length cable 5000 mm
 Longueur cable 5000 mm
 Kabellänge 5000 mm

CE   IP20

imagine your light

Design s.t. Fabas Luce

KIT COMPONENTI - MODULAR KITS

Struttura in metallo, vetri borosilicato o vetri soffiato - Metal frame, borosilicate glasses or blown glasses
Monture en métal, verres borosilicatés ou verres soufflés - Metall, Borosilikatgläser oder geblasene Gläser



suspension

Scegli la montatura, scegli il vetro:
componi la tua sospensione

Choose the frame, choose the glass:
create your suspension

Choisissez la monture, choisissez le verre:
créez votre suspension

Wählen Sie den Rahmen, wählen Sie das Glas:
erstellen Sie Ihre Aufhängung



imagine your light

Design s.t. Fabas Luce

Montatura / Frame / Monture / Halterung

Cavo non incluso – Cable not included – Câble pas inclus – Kabel nicht inklusiv

Ø 130



Tonda 1 luce
Round 1 light
Ronde 1 lumière
Rund 1-flammig



3481-57-101

■ Nero - Black - Noir - Schwarz



3481-57-102

□ Bianco - White - Blanc - Weiss

L 830 x 80

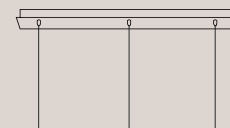

Rettangolare 3 luci
Rectangular 3 lights
Rectangulaire 3 lumières
Rechteckig 3-flammig



3481-53-101

■ Nero - Black - Noir - Schwarz



3481-53-102

□ Bianco - White - Blanc - Weiss

Ø 400

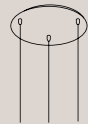

Tonda 3 luci Ø 400
Round 3 lights Ø 400
Ronde 3 lumières Ø 400
Rund 3-flammig Ø 400



3481-58-101

■ Nero - Black - Noir - Schwarz



3481-58-102

□ Bianco - White - Blanc - Weiss

L 1100 x 80

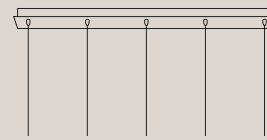

Rettangolare 5 luci
Rectangular 5 lights
Rectangulaire 5 lumières
Rechteckig 5-flammig

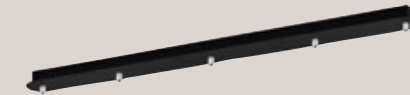

3481-55-101

■ Nero - Black - Noir - Schwarz



3481-55-102

□ Bianco - White - Blanc - Weiss

Ø 500

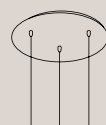

Tonda 3 luci Ø 500
Round 3 lights Ø 500
Ronde 3 lumières Ø 500
Rund 3-flammig Ø 500



3481-51-101

■ Nero - Black - Noir - Schwarz



3481-51-102

□ Bianco - White - Blanc - Weiss

L 900 x 250

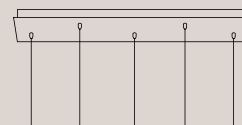

Rettangolare 5 luci
Rectangular 5 lights
Rectangulaire 5 lumières
Rechteckig 5-flammig



3481-54-101

■ Nero - Black - Noir - Schwarz



3481-54-102

□ Bianco - White - Blanc - Weiss

Ø 500

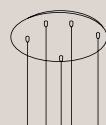

Tonda 5 luci Ø 500
Round 5 lights Ø 500
Ronde 5 lumières Ø 500
Rund 5-flammig Ø 500



3481-52-101

■ Nero - Black - Noir - Schwarz



3481-52-102

□ Bianco - White - Blanc - Weiss

L 900 x 300

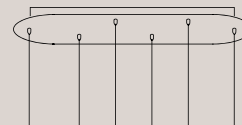

Ellittica 6 luci
Elliptical 6 lights
Elliptique 6 lumières
Elliptisch 6-flammig



3481-56-101

■ Nero - Black - Noir - Schwarz



3481-56-101

□ Bianco - White - Blanc - Weiss

Ø 180

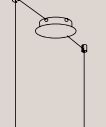

Tonda 2 luci
Round 2 lights
Ronde 2 lumières
Rund 2-flammig

Ø 250

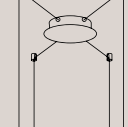

Tonda 4 luci
Round 4 lights
Ronde 4 lumières
Rund 4-flammig



3749-52-101

■ Nero - Black - Noir - Schwarz



3749-54-101



3749-52-102

□ Bianco - White - Blanc - Weiss



3749-54-102

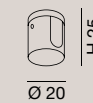

Supporto aggiuntivo per fissaggio cavo
Additional support for cable fixing
Support supplémentaire pour fixation câble
Zusätzlicher Kabelumlenker



3749-59-101

■ Nero - Black
Noir - Schwarz



3749-59-102

□ Bianco - White
Blanc - Weiss



3749-59-119

■ Ottone satinato - Satined brass
Laiton satiné - Messing satiniert



3749-59-138

■ Cromo - Chrome
Chromé - Verchromt

2 o 4 supporti neri per cavo inclusi
2 or 4 black supports for cable included
2 ou 4 supports noir pour câble inclus
2 oder 4 Kabelumlenker schwarz inklusiv

2 o 4 supporti cromati per cavo inclusi
2 or 4 chrome supports for cable included
2 ou 4 supports chromé pour câble inclus
2 oder 4 Kabelumlenker verchromt inklusiv

choose the glass

Vetri / Glass / Verrerie / Glas

Cavo incluso - Cable included - Câble inclus - Kabel inklusi

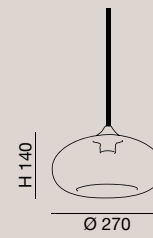

E27 60W

CE IP20

Cavo nero lunghezza 3500 mm
Black cable length 3500 mm
Câble noir longueur 3500 mm
Schwarzes Kabel, Länge 3500 mm



3489-50-125

Ambra - Amber
Ambre - Amber



3489-50-126

Fumé - Transparent grey
Gris transparent - Grau transparent

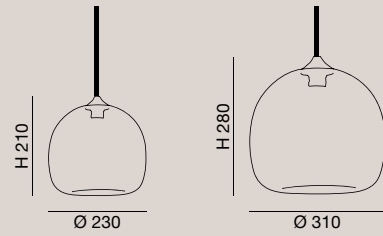

E27 40W

E27 60W

CE IP20

Cavo nero lunghezza 3500 mm
Black cable length 3500 mm
Câble noir longueur 3500 mm
Schwarzes Kabel, Länge 3500 mm



3490-59-125 3490-50-125

Ambra - Amber
Ambre - Amber



3490-59-126 3490-50-126

Fumé - Transparent grey
Gris transparent - Grau transparent

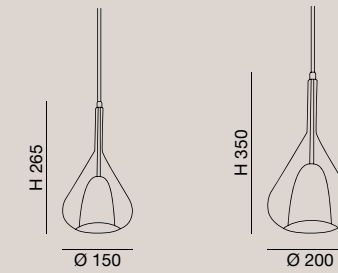

E14 40W

E27 40W

CE IP20

Cavo trasparente lunghezza 3500 mm
Transparent cable length 3500 mm
Câble transparent longueur 3500 mm
Transparentes Kabel, Länge 3500 mm



3481-59-125 3481-50-125

Ambra - Amber
Ambre - Amber



3481-59-126 3481-50-126

Fumé - Transparent grey
Gris transparent - Grau transparent

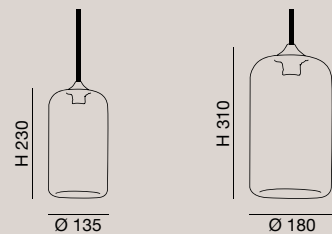

E27 40W

E27 60W

CE IP20

Cavo nero lunghezza 3500 mm
Black cable length 3500 mm
Câble noir longueur 3500 mm
Schwarzes Kabel, Länge 3500 mm



3491-59-125 3491-50-125

Ambra - Amber
Ambre - Amber



3491-59-126 3491-50-126

Fumé - Transparent grey
Gris transparent - Grau transparent



3481-59-140 3481-50-140

Verde trasparente - Transparent green
Vert transparent - Transparent grün



3481-59-241 3481-50-241

Trasparente - Transparent
Transparent - Transparent



3481-59-244 3481-50-244

Azzurro trasparente - Light blue
Bleu ciel - Azurblau

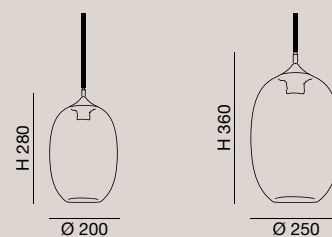

E27 60W

E27 60W

CE IP20

Cavo nero lunghezza 3500 mm
Black cable length 3500 mm
Câble noir longueur 3500 mm
Schwarzes Kabel, Länge 3500 mm



3519-59-365 3519-50-365

Cognac



3519-59-126 3519-50-126

Fumé - Transparent grey
Gris transparent - Grau transparent

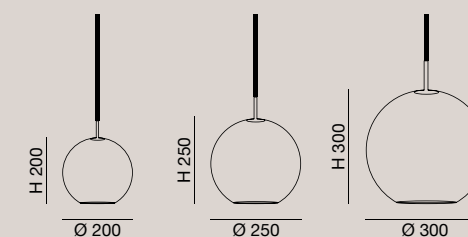

E27 40W

E27 40W

E27 40W

CE IP20

Cavo trasparente lunghezza 3500 mm
Transparent cable length 3500 mm
Câble transparent longueur 3500 mm
Transparent Kabel, Länge 3500 mm



3780-52-102

Bianco - White - Blanc - Weiss



3780-51-102



3780-50-102

imagine your light modular kits







3767

Struttura in metallo e vetro borosilicato - Metal frame and borosilicate glass
 Monture en métal et verre borosilicaté - Metall und Borsilicatglas



[See all collection](#)

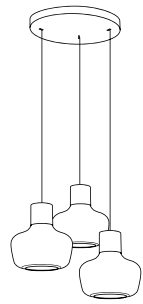

suspension p. 34

ceiling lamp



Blanc - Weiß Cognac

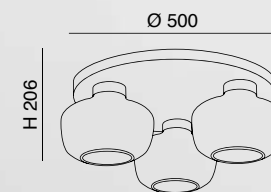

LED WARM WHITE
 36W - 3900 lm

3767-65-102 Bianco - White

3767-65-365 Cognac

Dimmerabile a step
 Steps dimmable
 Gradable
 Stufen dimmbar

CE IP20

kino 3767

3394

Struttura in metallo e metacrilato - Metal and methacrylate frame
Monture en métal et métachrylate - Metall und Methacrylat

[See all collection](#)

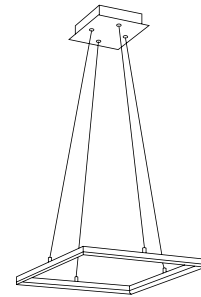

suspension p. 70

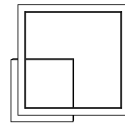

wall lamp p. 110

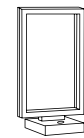

table lamp p. 164

- Noir - Schwarz Blanc - Weiss
- Or mat - Gold edelmatt Corten - Rostbraun
- Anthracite - Anthrazit



ceiling lamp

bard 3394

LED WARM WHITE
22W - 2160 lm

3394-21-101 Nero - Black

3394-21-102 Bianco - White

3394-21-225 Oro opaco - Matt Gold

3394-21-282 Antracite - Anthracite

3394-21-361 Corten - Rostbraun

LED dimmerabile a taglio di fase
Phase cut dimmable LED
LED dimmable à découpage de phase
LED dimmbar (über Phasen- und abschnittdimmer)

Integrato - Integrated - Intégré - Integriert
[Pagina - Page - Seite 207]

CE

LED NATURAL WHITE
22W - 2250 lm

3394-23-102 Bianco - White

3394-23-282 Antracite - Anthracite

LED dimmerabile a taglio di fase
Phase cut dimmable LED
LED dimmable à découpage de phase
LED dimmbar (über Phasen- und abschnittdimmer)

Integrato - Integrated - Intégré - Integriert
[Pagina - Page - Seite 207]

CE

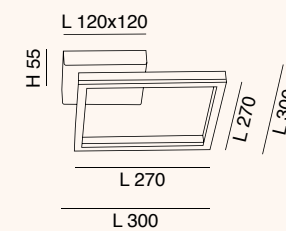

- Noir - Schwarz Blanc - Weiss
- Or mat - Gold edelmatt Corten - Rostbraun
- Anthracite - Anthrazit



* Montaggio a parete o soffitto
Wall or ceiling mounting
Montage au mur ou au plafond
Wand- oder Deckenmontage

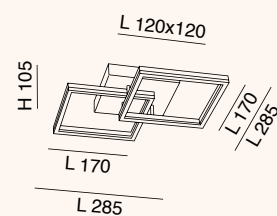

LED WARM WHITE
21W - 2160 lm

3394-28-101 Nero - Black

3394-28-102 Bianco - White

3394-28-225 Oro opaco - Matt Gold

3394-28-282 Antracite - Anthracite

3394-28-361 Corten - Rostbraun

LED dimmerabile a taglio di fase
Phase cut dimmable LED
LED dimmable à découpage de phase
LED dimmbar (über Phasen-
und abschnittdimmer)

CE IP20





- Noir - Schwarz Blanc - Weiss
- Or mat - Gold edelmatt Corten - Rostbraun
- Anthracite - Anthrazit

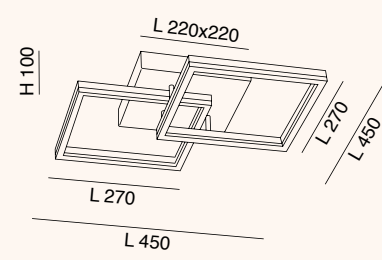
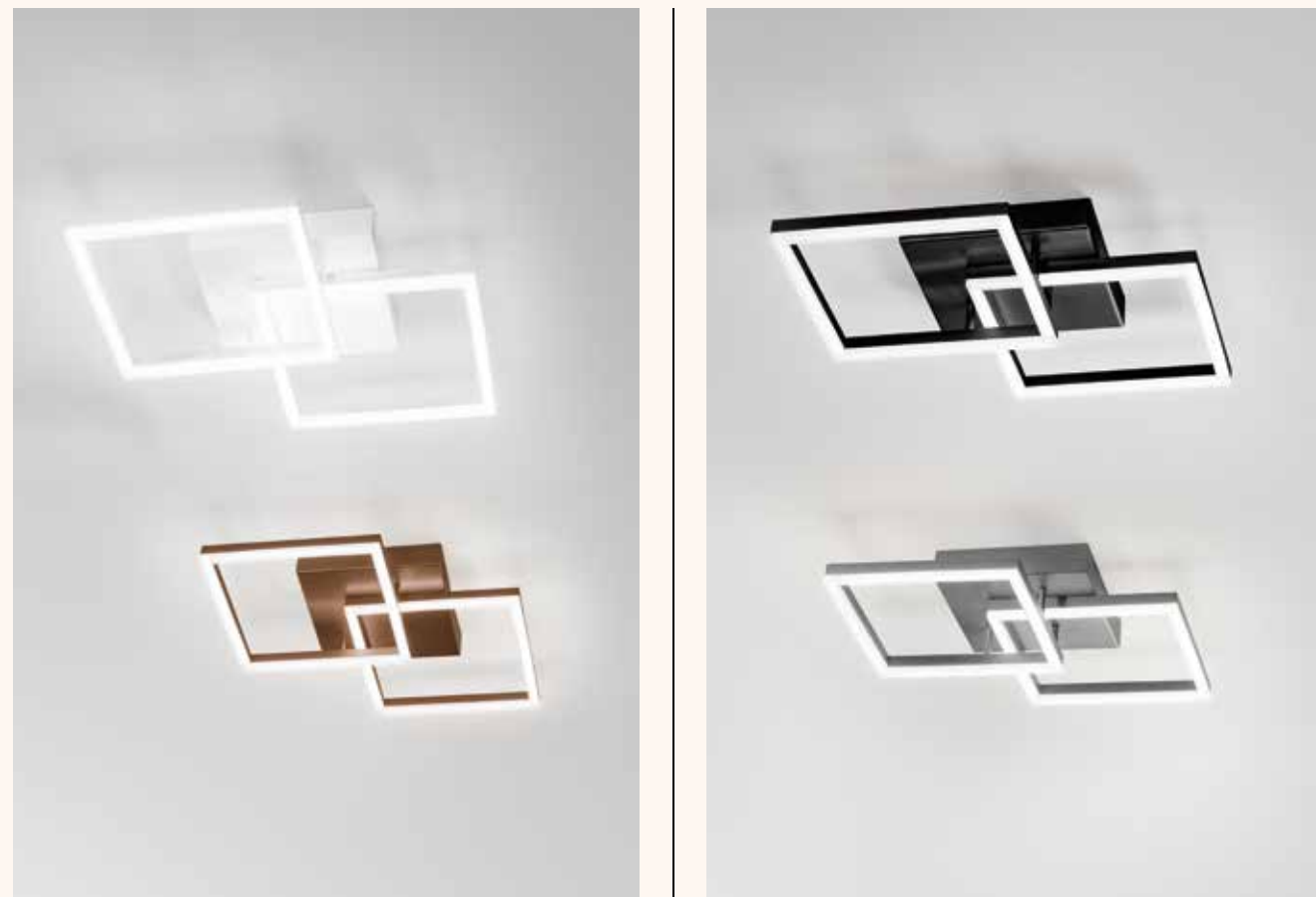

LED WARM WHITE
39W - 3880 lm

- 3394-22-101** Nero - Black
- 3394-22-102** Bianco - White
- 3394-22-225** Oro opaco - Matt Gold
- 3394-22-282** Antracite - Anthracite
- 3394-22-361** Corten - Rostbraun

LED dimmerabile a taglio di fase
Phase cut dimmable LED
LED dimmable à découpage de phase
LED dimmbar (über Phasen- und abschnitt-dimmer)

Integrato - Integrated - Intégré - Integriert
[Pagina - Page - Seite 207]

CE

LED NATURAL WHITE
39W - 4050 lm

- 3394-29-102** Bianco - White
- 3394-29-282** Antracite - Anthracite

LED dimmerabile a taglio di fase
Phase cut dimmable LED
LED dimmable à découpage de phase
LED dimmbar (über Phasen- und abschnitt-dimmer)

Integrato - Integrated - Intégré - Integriert
[Pagina - Page - Seite 207]

CE

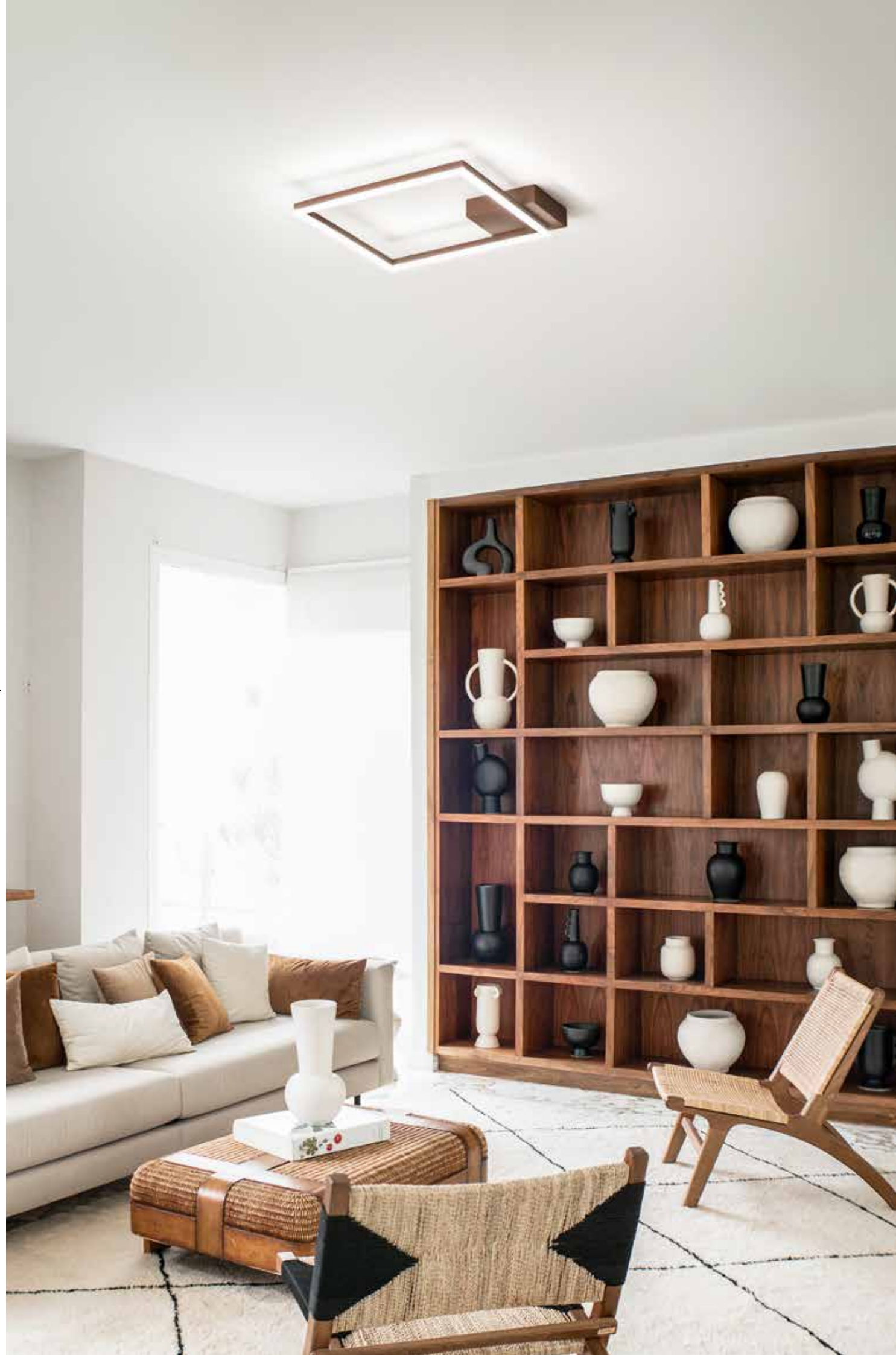

- Noir - Schwarz Blanc - Weiss
- Or mat - Gold edelmatt Corten - Rostbraun
- Anthracite - Anthrazit



LED WARM WHITE
39W - 3880 lm

- 3394-61-101** Nero - Black
- 3394-61-102** Bianco - White
- 3394-61-225** Oro opaco - Matt Gold
- 3394-61-282** Antracite - Anthracite
- 3394-61-361** Corten - Rostbraun

LED dimmerabile a taglio di fase
Phase cut dimmable LED
LED dimmable à découpage de phase
LED dimmbar (über Phasen- und abschnittdimmer)

Integrato - Integrated - Intégré - Integriert
[Pagina - Page - Seite 207]

CE IP20

LED NATURAL WHITE
39W - 4050 lm

- 3394-62-102** Bianco - White
- 3394-62-282** Antracite - Anthracite

LED dimmerabile a taglio di fase
Phase cut dimmable LED
LED dimmable à découpage de phase
LED dimmbar (über Phasen- und abschnittdimmer)

Integrato - Integrated - Intégré - Integriert
[Pagina - Page - Seite 207]

CE IP20

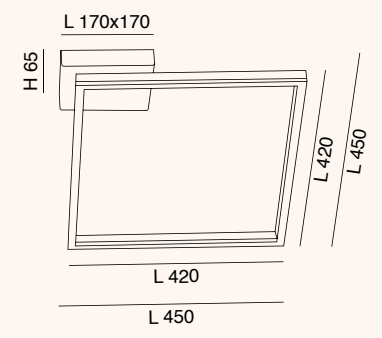



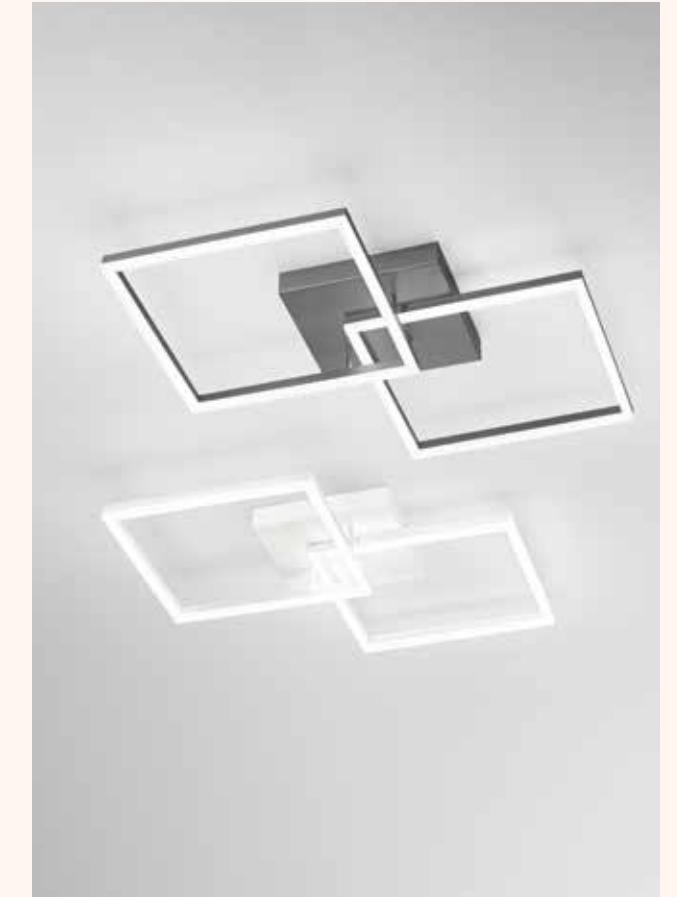
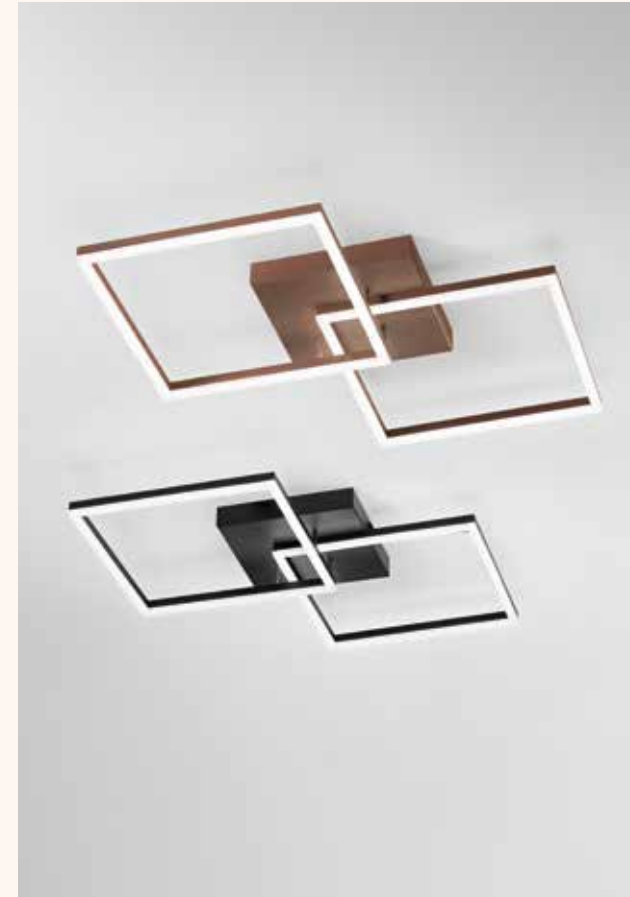

- Noir - Schwarz Blanc - Weiss
- Or mat - Gold edelmatt Corten - Rostbraun
- Anthracite - Anthrazit



LED WARM WHITE
52W - 5180 lm

- 3394-65-101** Nero - Black
- 3394-65-102** Bianco - White
- 3394-65-225** Oro opaco - Matt Gold
- 3394-65-282** Antracite - Anthracite
- 3394-65-361** Corten - Rostbraun

 LED dimmerabile a taglio di fase
Phase cut dimmable LED
LED dimmable à découpage de phase
LED dimmbar (über Phasen- und abschnittdimmer)

 Integrato - Integrated - Intégré - Integriert
[Pagina - Page - Seite 207]

CE   IP20

LED NATURAL WHITE
52W - 5400 lm

- 3394-66-102** Bianco - White
- 3394-66-282** Antracite - Anthracite

 LED dimmerabile a taglio di fase
Phase cut dimmable LED
LED dimmable à découpage de phase
LED dimmbar (über Phasen- und abschnittdimmer)

 Integrato - Integrated - Intégré - Integriert
[Pagina - Page - Seite 207]

CE   IP20

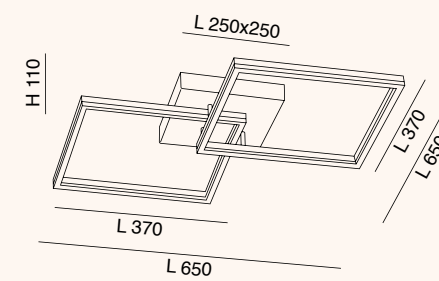

relais Design s.t. Fabas Luce

3709

Struttura in metallo e policarbonato - Metal and polycarbonate frame
Structure en métal et polycarbonate - Metall- und Polycarbonatstruktur



ceiling lamp

Noir - Schwarz  Blanc - Weiss 



relais 3709

 **LED WARM WHITE - NATURAL WHITE**
40W (+ FAN 35W) - 4740 lm

3709-65-101  Nero - Black

3709-65-102  Bianco - White

 Warm white ↔ Natural white

 Con telecomando - With remote control
Avec télécommande - Mit Fernbedienung

CE  IP20

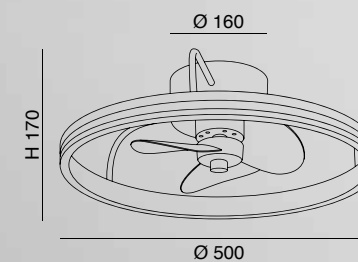

savoy by Design s.t. Fabas Luce

3710

Struttura in metallo e policarbonato - Metal and polycarbonate frame
Structure en métal et polycarbonate - Metall- und Polycarbonatstruktur

Noir - Schwarz  Blanc - Weiss 

ceiling lamp





savoy 3710

 **LED WARM WHITE - NATURAL WHITE**
40W (+ FAN 35W) - 4740 lm

3710-65-101  Nero - Black

3710-65-102  Bianco - White

 Warm white ↔ Natural white

 Con telecomando - With remote control
Avec télécommande - Mit Fernbedienung

CE   IP20

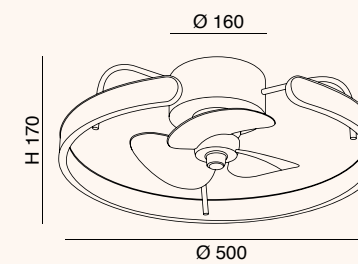

3451

Struttura in pressofusione di alluminio - Aluminium die-casting structure
Structure de moulage en aluminium - Aluminiumdruckguss

[See all collection](#)

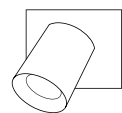

wall lamp p. 138

ceiling lamp



Noir - Schwarz Blanc - Weiss

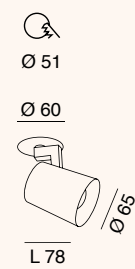

GU10
1x35W



3451-91-101 Nero - Black

Con anello oro aggiuntivo
With additional gold ring
Avec bague en or supplémentaire
Mit zusätzlichem Goldring



3451-91-102 Bianco - White

 Orientabile - Adjustable
Réglable - Schwenkbar

Attenzione: lampadina non fornita
Warning: bulb not supplied
Attention: ampoule pas fournie
Achtung: Leuchtmittel nicht mitgeliefert

CE   IP20



Noir - Schwarz  Blanc - Weiss 
 Aluminium - Aluminium 



GU10

4x35W

3451-84-101  Nero - Black

Con anello oro aggiuntivo
 With additional gold ring
 Avec bague en or supplémentaire
 Mit zusätzlichem Goldring



3451-84-102  Bianco - White

3451-84-212  Alluminio - Aluminum

 Orientabile - Adjustable
 Réglable - Schwenkbar

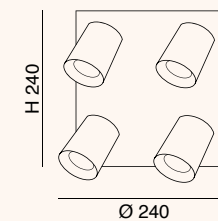
Attenzione: lampadina non fornita
 Warning: bulb not supplied
 Attention: ampoule pas fournie
 Achtung: Leuchtmittel nicht mitgeliefert



CE   IP20

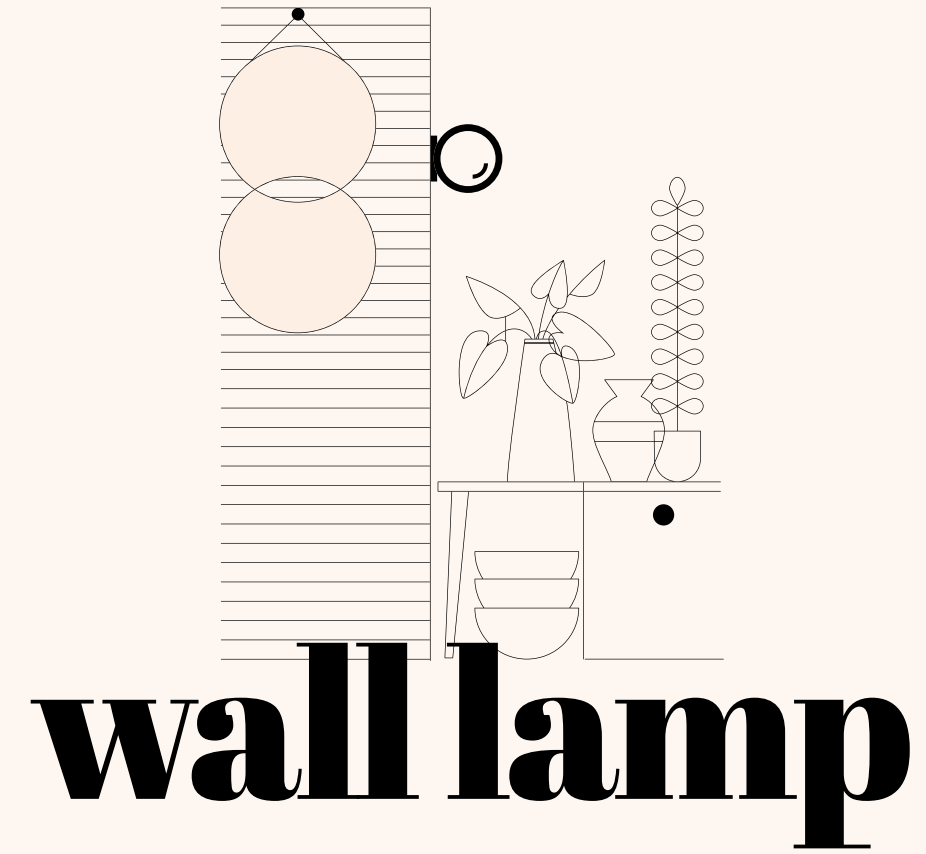

wall lamp

3394

Struttura in metallo e metacrilato - Metal and methacrylate frame
Monture en métal et métachrylate - Metall und Methacrylat

[See all collection](#)



wall lamp

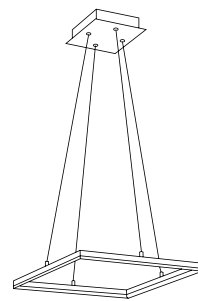

suspension p. 70

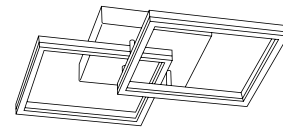

ceiling lamp p. 90

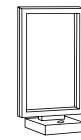

table lamp p. 164

- Noir - Schwarz Blanc - Weiss
- Or mat - Gold edelmatt Corten - Rostbraun
- Anthracite - Anthrazit



* Montaggio a parete o soffitto
Wall or ceiling mounting
Montage au mur ou au plafond
Wand- oder Deckenmontage

E LED WARM WHITE
11W - 1080 lm

3394-24-101 Nero - Black

3394-24-102 Bianco - White

3394-24-225 Oro opaco - Matt Gold

3394-24-282 Antracite - Anthracite

3394-24-361 Corten - Rostbraun

LED dimmerabile a taglio di fase
Phase cut dimmable LED
LED dimmable à découpage de phase
LED dimmbar (über Phasen- und abschnittdimmer)

CE IP20

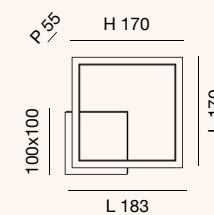

3618

Struttura in metallo e metacrilato - Metal and methacrylate frame
 Monture en métal et métachrylate - Metall und Methacrylat

wall lamp



Blanc - Weiss   Laiton satiné - Messing satiniert
 Anthracite - Anthrazit 

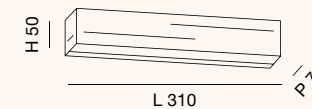

 **LED WARM WHITE**
 18W - 1700 lm



3618-21-102  Bianco - White

3618-21-119  Ottone satinato
 Satined brass

3618-21-282  Antracite - Anthracite

CE   IP20



Blanc - Weiss  Laiton satiné - Messing satiniert 
 Anthracite - Anthrazit 

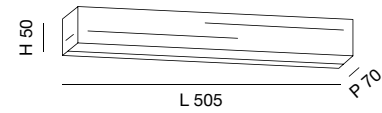
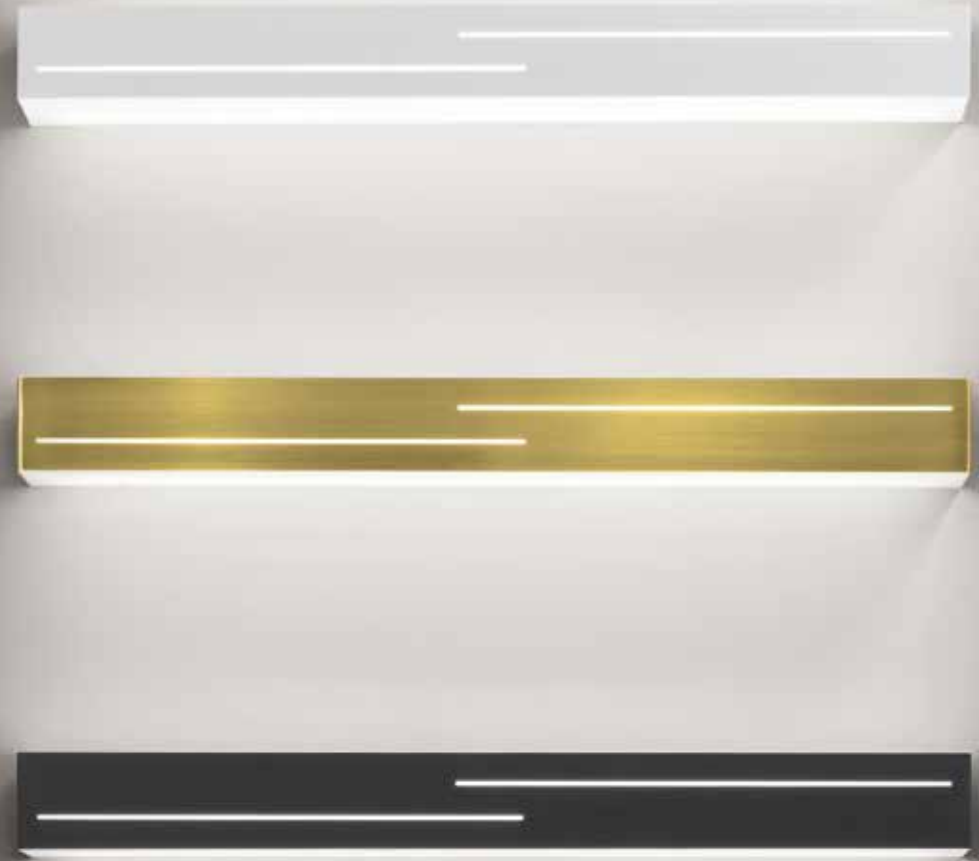

 **LED WARM WHITE**
 24W - 2260 lm

3618-26-102  Bianco - White

3618-26-119  Ottone satinato
 Satined brass

3618-26-282  Antracite - Anthracite

CE   IP20

3239

Struttura in metallo e metacrilato - Metal and methacrylate frame
 Monture en métal et métachrylate - Metall und Methacrylat

[See all collection](#)

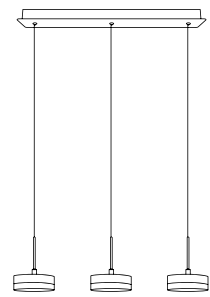

suspension p. 66

wall lamp

Laiton satiné - Messing satiniert   Aluminium brossé - Aluminium gebürstet





dunk 3239

LED WARM WHITE
 16W - 1510 lm

3239-21-119  Ottone satinato
 Satined brass

3239-21-212  Alluminio spazzolato
 Brushed aluminum

 Orientabile - Adjustable
 Réglable - Schwenkbar

 Compatibile - Compatible - Kompatibel
 [Pagina - Page - Seite 207]

CE   IP20

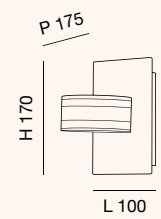



Ambre - Amber   Gris transparent - Grau transparent
 Transparent - Transparent 

wall lamp



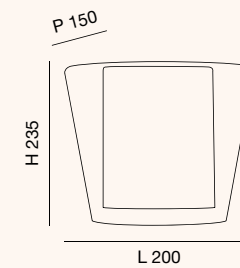

viki 3682





E27
1x40W

3682-21-125  Ambra - Amber

3682-21-126  Fumé - Transparent grey

3682-21-241  Trasparente - Transparent

CE   IP20

3707

Struttura in metallo, vetro e metacrilato - Metal, glass and methacrylate frame
 Monture en métal, verre et métachrylate - Metall, Glas und Methacrylat



Ambre - Amber   Gris transparent - Grau transparent
 Transparent - Transparent 

Ø wall lamp



maribel 3707

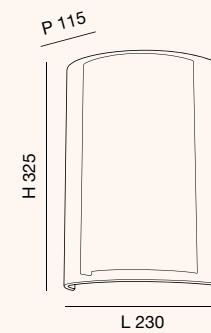



E27
 1x40W

3707-21-125  Ambra - Amber

3707-21-126  Fumé - Transparent grey

3707-21-241  Trasparente - Transparent

CE   IP20

alide Design MBDO

3708

Struttura in metallo, vetro e metacrilato - Metal, glass and methacrylate frame
Monture en métal, verre et métachrylate - Metall, Glas und Methacrylat



Ambre - Amber  Gris transparent - Grau transparent 
Transparent - Transparent 

wall lamp



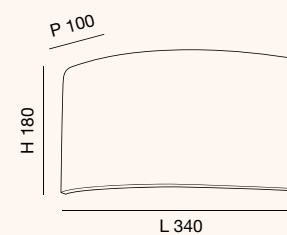

alide 3708





E27
1x40W

3708-21-125  Ambra - Amber

3708-21-126  Fumé - Transparent grey

3708-21-241  Trasparente - Transparent

CE   IP20

[See all collection](#)



wall lamp



table lamp p. 168

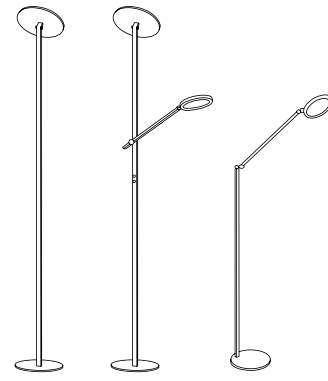



floor lamp p. 182

Noir - Schwarz   Blanc - Weiss
Aluminium - Aluminium 



regina 3551

 **LED WARM WHITE - COLD WHITE**
9W - 1135 lm

3551-21-101  Nero - Black

3551-21-102  Bianco - White

3551-21-212  Alluminio - Aluminum

 Regolazione luce al tocco
Touch dimmer
Variateur sensitif
Touchdimmer

 Orientabile - Adjustable
Réglable - Schwenkbar

 Warm white ↔ Cold white

Dotata di cavo - Equipped with cable.
Equipé d'un câble. - Ausgestattet mit Kabel.

CE  IP20

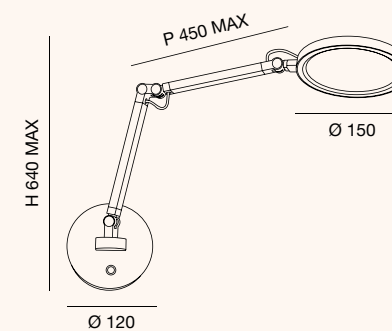

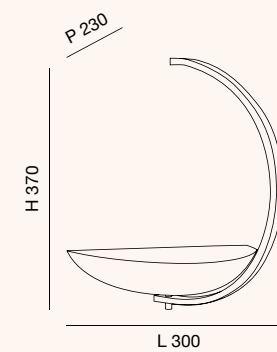

LED WARM WHITE
9.5W - 960 lm

3715-20-101 ■ Nero - Black

Regolazione luce al tocco
Touch dimmer
Variateur sensitif
Touchdimmer

Orientabile - Adjustable
Réglable - Schwenkbar

CE IP20



LED WARM WHITE
9W + 6,5W - 750 lm + 630 lm

3717-20-101 Nero - Black

3717-20-102 Bianco - White

Regolazione luce al tocco
Touch dimmer
Variateur sensitif
Touchdimmer

Orientabile - Adjustable
Réglable - Schwenkbar

USB charger

Con retroilluminazione
With backlight
Avec rétroéclairage
Mit Rückbeleuchtung

CE IP20

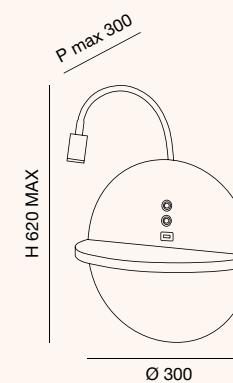

3361

Struttura in metallo e metacrilato - Metal and methacrylate frame
 Monture en métal et métachrylate - Metall und Methacrylat



wall lamp

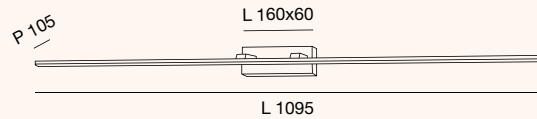

LED WARM WHITE
 20W - 2460 lm

3361-29-101 ■ Nero - Black

3361-29-102 □ Bianco - White

3361-29-138 ■ Cromo - Chrome

CE IP44

Noir - Schwarz ■ Blanc - Weiss □
 Chromé - Verchromt ■

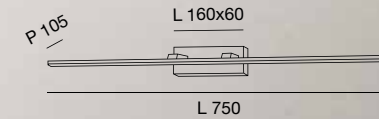

LED WARM WHITE
 15W - 1850 lm



3361-28-101 ■ Nero - Black

3361-28-102 □ Bianco - White

3361-28-138 ■ Cromo - Chrome

CE IP44

nala 3361

Noir - Schwarz   Blanc - Weiss
 Chromé - Verchromt 

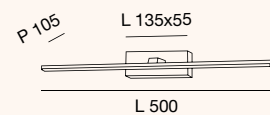

 **LED WARM WHITE**
 10W - 1200 lm

3361-26-101  Nero - Black

3361-26-102  Bianco - White

3361-26-138  Cromo - Chrome

CE   IP44

Noir - Schwarz   Blanc - Weiss
 Chromé - Verchromt 

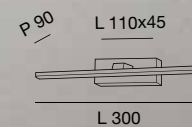



 **LED WARM WHITE**
 6W - 700 lm

3361-21-101  Nero - Black

3361-21-102  Bianco - White

3361-21-138  Cromo - Chrome

CE   IP44

3719

Struttura in metallo e metacrilato - Metal and methacrylate frame
 Monture en métal et métachrylate - Metall und Methacrylat

wall lamp

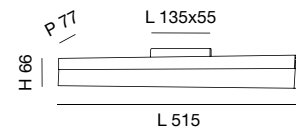
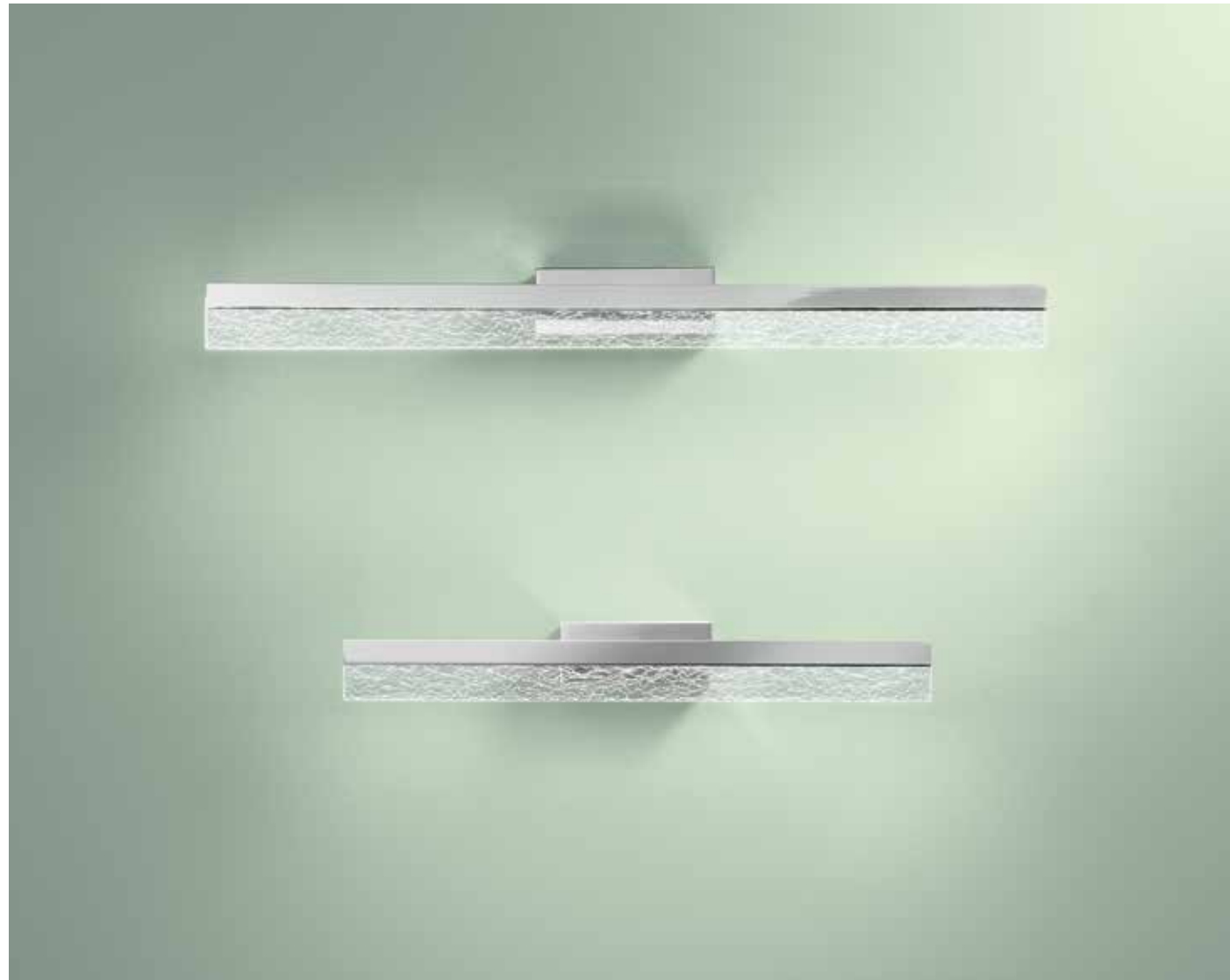

LED WARM WHITE
 12W - 660 lm

3719-26-138 Cromo - Chrome

CE IP44

Chromé - Verchromt

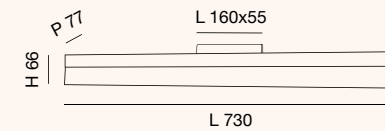

LED WARM WHITE
 15W - 825 lm

3719-28-138 Cromo - Chrome

CE IP44

Struttura in metallo e metacrilato - Metal and methacrylate frame
Monture en métal et métachrylate - Metall und Methacrylat

wall lamp

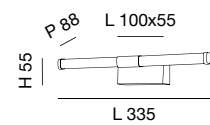

LED WARM WHITE
8W - 480 lm

3720-21-101 ■ Nero - Black

3720-21-138 ■ Cromo - Chrome

CE IP44

Noir - Schwarz Chromé - Verchromt

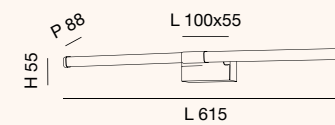

LED WARM WHITE
14W - 840 lm

3720-26-101 ■ Nero - Black

3720-26-138 ■ Cromo - Chrome

CE IP44

3451

Struttura in pressofusione di alluminio - Aluminium die-casting structure
Structure de moulage en aluminium - Aluminiumdruckguss

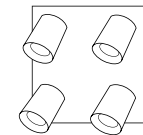

[See all collection](#)



ceiling lamp p. 104

wall lamp



Noir - Schwarz  Blanc - Weiss 
Aluminium - Aluminium 



modo 3451

GU10

1x35W

3451-81-101  Nero - Black

Con anello oro aggiuntivo
With additional gold ring
Avec bague en or supplémentaire
Mit zusätzlichem Goldring



3451-81-102  Bianco - White

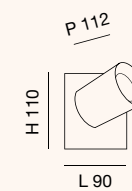

3451-81-212  Alluminio - Aluminium

 Orientabile - Adjustable
Réglable - Schwenkbar

Attenzione: lampadina non fornita
Warning: bulb not supplied
Attention: ampoule pas fournie
Achtung: Leuchtmittel nicht mitgeliefert



CE   IP20

Noir - Schwarz  Blanc - Weiss 
 Aluminium - Aluminium 



GU10

2x35W

3451-82-101  Nero - Black

Con anello oro aggiuntivo
 With additional gold ring
 Avec bague en or supplémentaire
 Mit zusätzlichem Goldring

3451-82-102  Bianco - White

3451-82-212  Alluminio - Aluminum

 Orientabile - Adjustable
 Réglable - Schwenkbar

Attenzione: lampadina non fornita
 Warning: bulb not supplied
 Attention: ampoule pas fournie
 Achtung: Leuchtmittel nicht mitgeliefert

CE  IP20

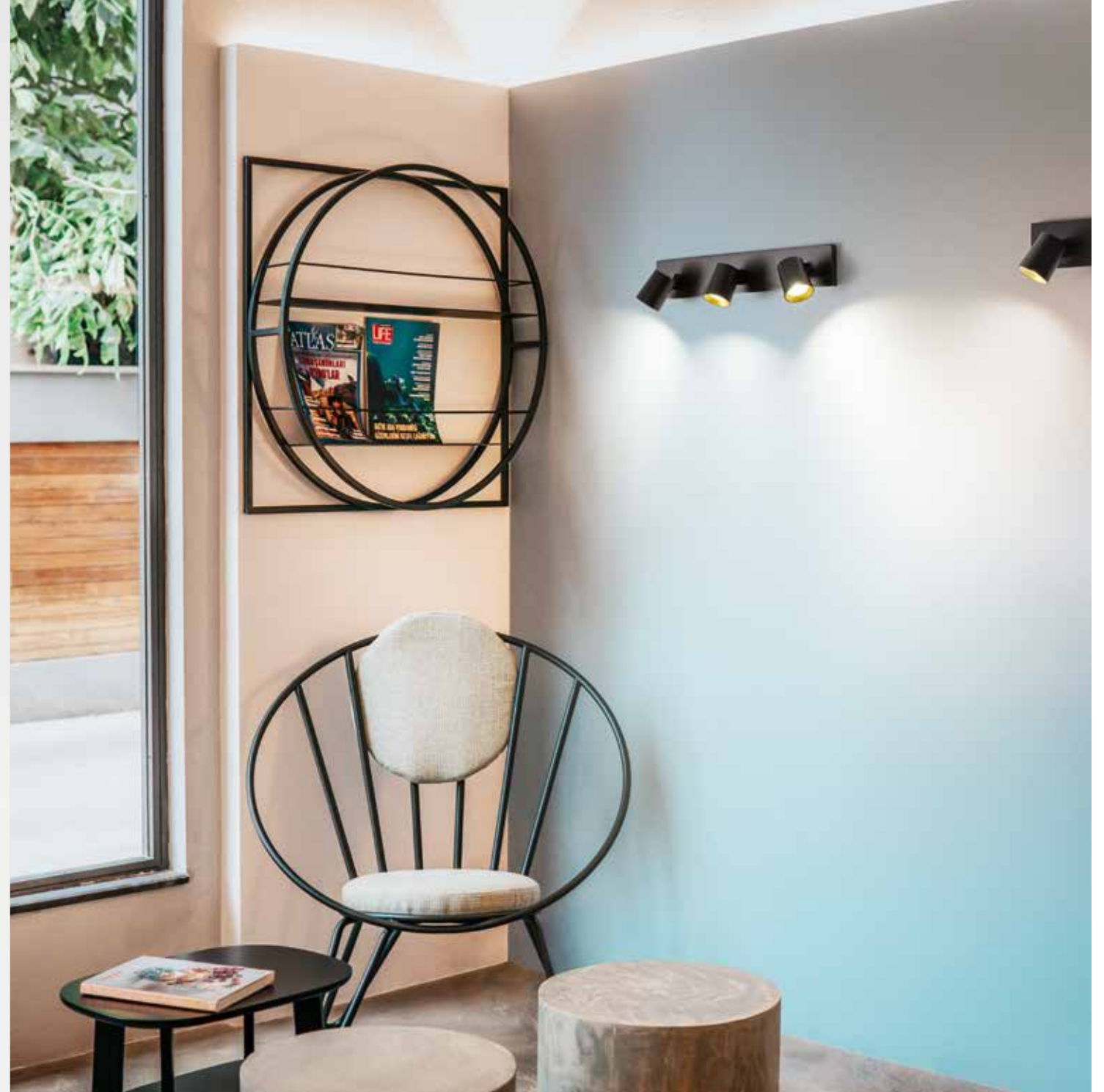
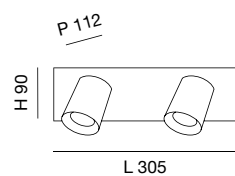

GU10

3x35W

3451-83-101  Nero - Black

Con anello oro aggiuntivo
 With additional gold ring
 Avec bague en or supplémentaire
 Mit zusätzlichem Goldring

3451-83-102  Bianco - White

3451-83-212  Alluminio - Aluminum

 Orientabile - Adjustable
 Réglable - Schwenkbar

Attenzione: lampadina non fornita
 Warning: bulb not supplied
 Attention: ampoule pas fournie
 Achtung: Leuchtmittel nicht mitgeliefert

CE  IP20

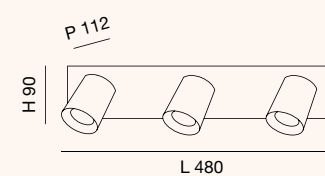



GU10

2x35W

3451-82-101 ■ Nero - Black

Con anello oro aggiuntivo
With additional gold ring
Avec bague en or supplémentaire
Mit zusätzlichem Goldring

3451-82-102 □ Bianco - White

3451-82-212 ■ Alluminio - Aluminum

⤴ Orientabile - Adjustable
Réglable - Schwenkbar

Attenzione: lampadina non fornita
Warning: bulb not supplied
Attention: ampoule pas fournie
Achtung: Leuchtmittel nicht mitgeliefert

CE IP20

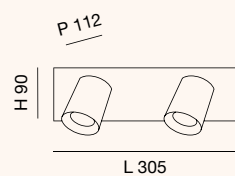

Noir - Schwarz ■ Blanc - Weiss □
Aluminium - Aluminium ■



GU10

3x35W

3451-83-101 ■ Nero - Black

Con anello oro aggiuntivo
With additional gold ring
Avec bague en or supplémentaire
Mit zusätzlichem Goldring

3451-83-102 □ Bianco - White

3451-83-212 ■ Alluminio - Aluminum

⤴ Orientabile - Adjustable
Réglable - Schwenkbar

Attenzione: lampadina non fornita
Warning: bulb not supplied
Attention: ampoule pas fournie
Achtung: Leuchtmittel nicht mitgeliefert

CE IP20

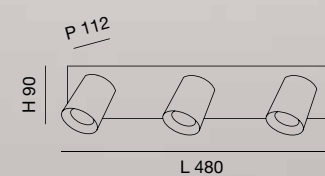





3760

Struttura in metallo e plastica vegetale - Metal frame and bio-based plastic
 Monture en métal et plastique végétal - Metall und biobasierter Kunststoff

table lamp

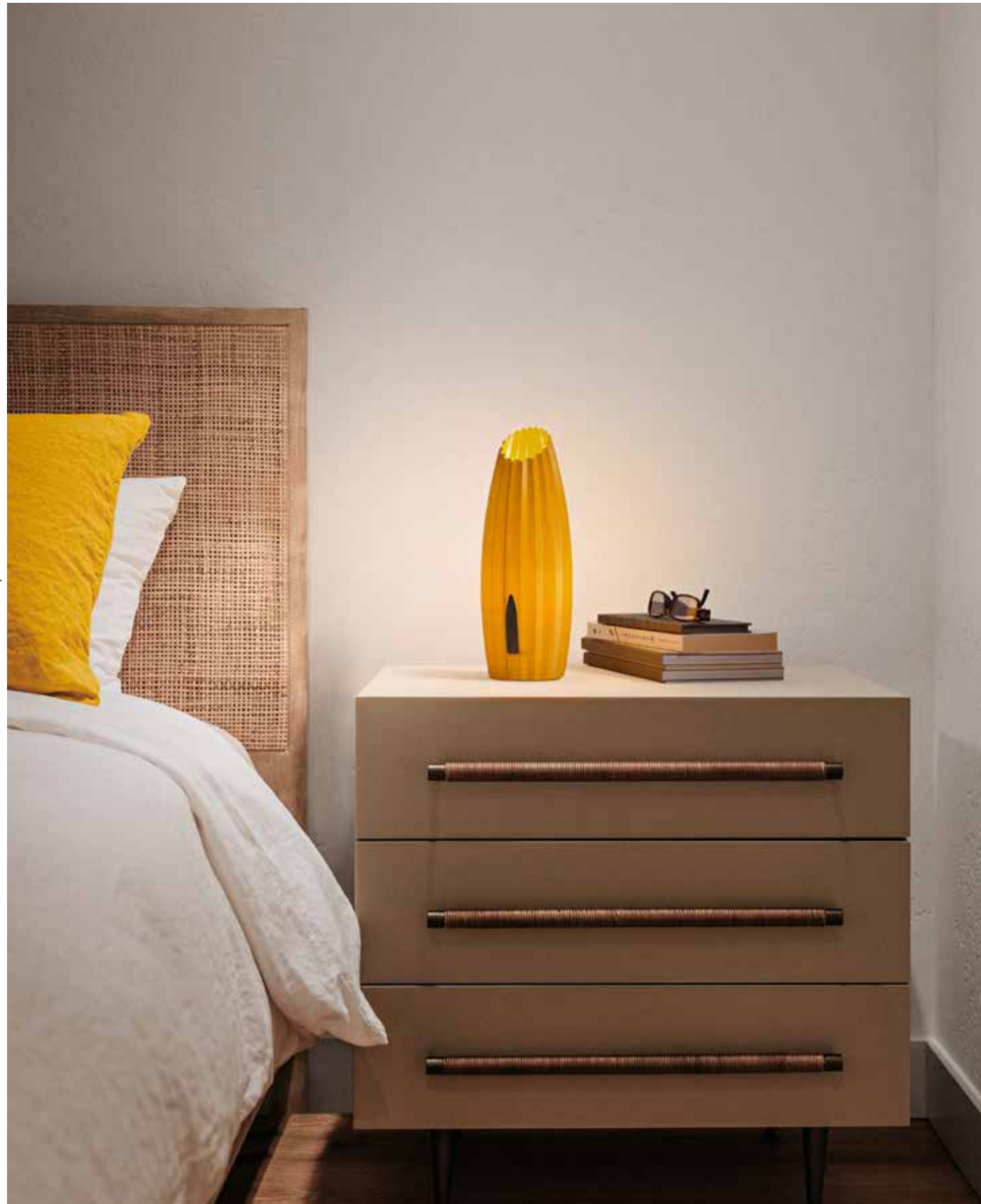

Blanc - Weiß Couleur moutard - Senffarbe
 Bordeaux



nadine 3760

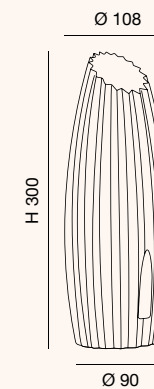

G9
1x10W

3760-30-102 Bianco - White

3760-30-133 Bordeaux - Burgundy





3760-30-367 Senape - Mustard colored

Regolazione luce al tocco
 Touch dimmer
 Variateur sensitif
 Touchdimmer

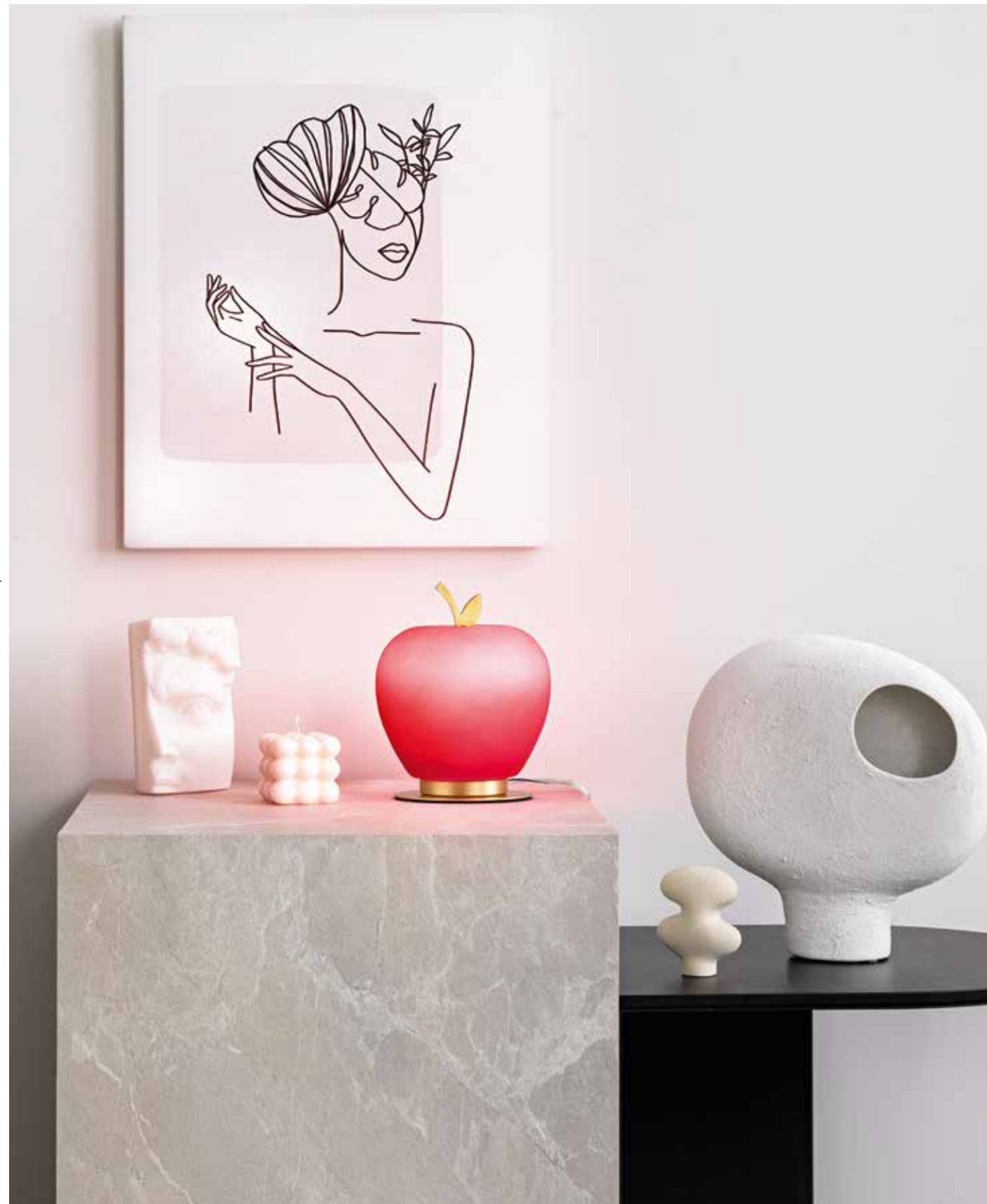
Lampadina G9 LED 3W dimmerabile inclusa
 Bulb G9 LED 3W dimmable included
 Ampoule G9 LED 3W dimmable incluse
 G9 LED 3W dimmbares LM inklusive

CE IP20



Blanc/Laiton satiné - Weiß/Messing satiniert   Rouge/Laiton satiné - Rot/Messing satiniert
Blanc/Chromé - Weiß/Verchromt   Vert/Laiton satiné - Grün/Messing satiniert



LED WARM WHITE
8W - 780lm

3762-30-102  Bianco/Ottone satinato
White/Satined brass

3762-30-104  Rosso/Ottone satinato
Red/Satined brass

3762-30-138  Bianco/Cromato
White/Chromed

3762-30-155  Verde/Ottone satinato
Green/Satined brass

Regolazione luce al tocco
Touch dimmer
Variateur sensitif
Touchdimmer

CE   IP20

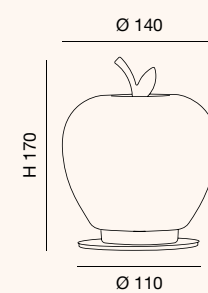



- Blanc/Laiton satiné - Weiß/Messing satiniert
- Blanc/Chromé - Weiß/Verchromt
- Vert/Laiton satiné - Grün/Messing satiniert
- Orange/Laiton satiné - Orange/Messing satiniert

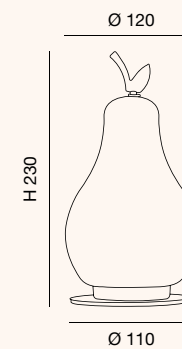

E LED WARM WHITE
 8W - 780lm

3763-30-102 Bianco/Ottone satinato
 White/Satined brass

3763-30-138 Bianco/Cromato
 White/Chromed

3763-30-155 Verde/Ottone satinato
 Green/Satined brass

3763-30-170 Arancio/Ottone satinato
 Orange/Satined brass

Regolazione luce al tocco
 Touch dimmer
 Variateur sensitif
 Touchdimmer

CE IP20







Noir - Schwarz   Blanc - Weiß
Rouge - Rot   Ambre - Amber

table lamp





freddy 3752

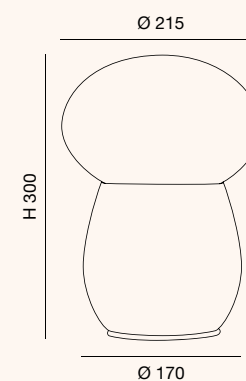



E27

1x40W



3752-30-101  Nero - Black

3752-30-102  Bianco - White

3752-30-104  Rosso - Red

3752-30-125  Ambra - Amber

 Con interruttore
With switch
Avec interrupteur
Mit Schalter

CE   IP20

victoria Fly Design

3783

Vetro soffiato - Blown glass
Verre soufflé - Geblasenes Glas



Blanc - Weiss

HO table lamp



victoria 3783

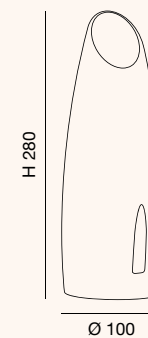

G9
1x20W

3783-30-102 Bianco - White

Regolazione luce al tocco
Touch dimmer
Variateur sensitif
Touchdimmer

Lampadina G9 LED 3W dimmerabile inclusa
Bulb G9 LED 3W dimmable included
Ampoule G9 LED 3W dimmable incluse
G9 LED 3W dimmbares LM inklusive

CE IP20



See all collection

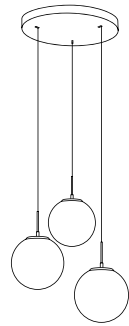

suspension p. 20

table lamp

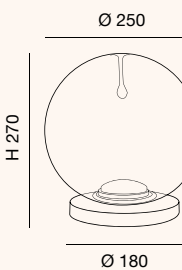

Transparent/goutte
 Transparent/Tropfen



LED
 WARM WHITE - NATURAL WHITE
 11W - 1080 lm
3770-30-372 Trasparente/Goccia
 Transparente/Drop
 Regolazione luce al tocco
 Touch dimmer
 Variateur sensitif
 Touchdimmer
 Warm white ↔ Natural white
 CE IP20

Struttura in metallo, legno e vetro soffiato - Metal frame, wood, blown glass
 Monture en métal, bois et verre soufflé - Metall, Holz und geblasenes Glas





Noir - Schwarz   Chêne - Eichenholz
 Jaune/rouge/noir - Gelb/Rot/Schwarz 





table lamp

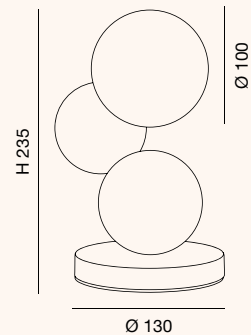

G9

1x20W

3754-30-101  Nero - Black

3754-30-215  Quercia - Oak

3754-30-366  Giallo/rosso/nero - Yellow/red/black

Regolazione luce al tocco
 Touch dimmer
 Variateur sensitif
 Touchdimmer

Lampadina G9 LED 3W dimmerabile inclusa
 Bulb G9 LED 3W dimmable included
 Ampoule G9 LED 3W dimmable incluse
 G9 LED 3W dimmbares LM inklusive

CE   IP20



micky 3754



Noir - Schwarz  Laiton satiné - Messing satiniert 
 Nickel satiné - Nickel satiniert 

table lamp

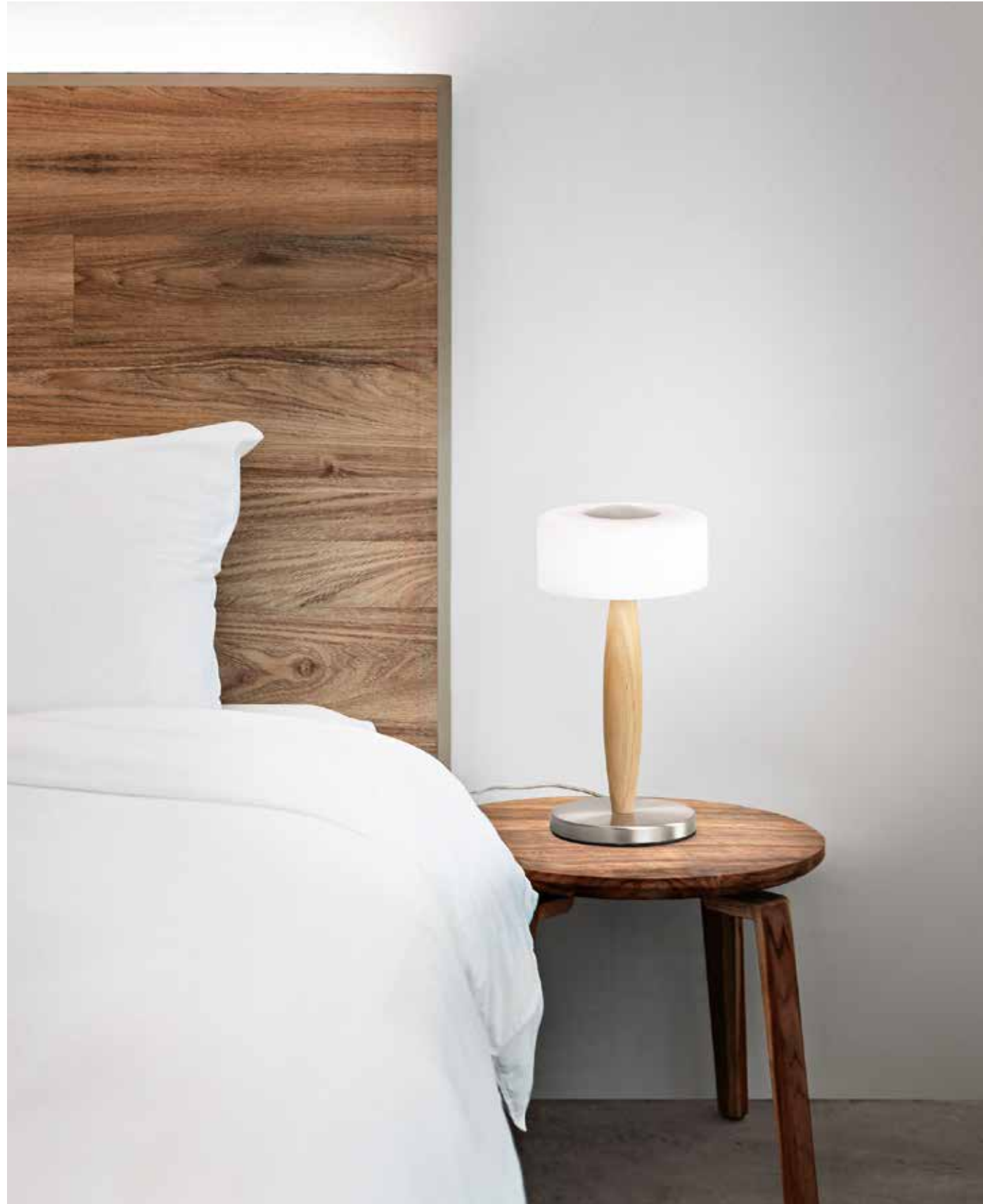

clea 3761

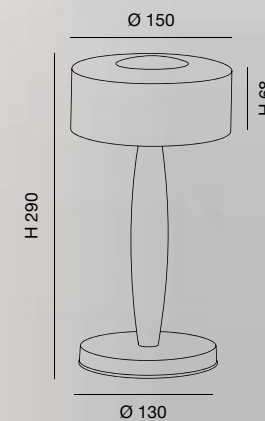

E LED WARM WHITE
 8W - 860 lm

3761-30-101  Nero - Black

3761-30-119  Ottone satinato - Satined brass

3761-30-178  Nichel satinato - Satined nickel

 Regolazione luce al tocco
 Touch dimmer
 Variateur sensitif
 Touchdimmer

CE   IP20



3703

Struttura in metallo e vetro soffiato - Metal frame and blown glass
 Monture en métal et verre soufflé - Metall und geblasenes Glas

table lamp



Noir - Schwarz  Blanc - Weiss 
 Laiton satiné - Messing satiniert  Nickel satiné - Nickel satiniert 



ibla 3703

 **LED WARM WHITE**
 9W - 750 lm

3703-30-101  Nero - Black

3703-30-102  Bianco - White

3703-30-119  Ottone satinato - Satined brass

3703-30-178  Nichel satinato - Satined nickel

 Regolazione luce al tocco
 Touch dimmer
 Variateur sensitif
 Touchdimmer

CE   IP20

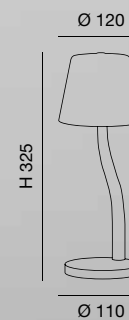

3394

Struttura in metallo e metacrilato - Metal and methacrylate frame
Monture en métal et métachrylate - Metall und Methacrylat

[See all collection](#)

table lamp

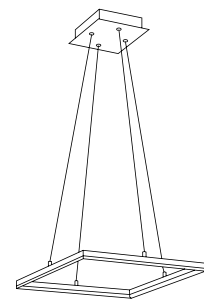

suspension p. 70

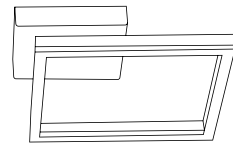

ceiling lamp p. 90

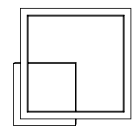

wall lamp p. 110

- Noir - Schwarz Blanc - Weiss
- Or mat - Gold edelmatt Corten - Rostbraun
- Anthracite - Anthrazit



bard 3394

LED WARM WHITE
15W - 1720 lm

3394-30-101 Nero - Black

3394-30-102 Bianco - White

3394-30-225 Oro opaco - Gold matt

3394-30-282 Antracite - Anthracite

3394-30-361 Corten

Regolazione luce con pulsante
Push dimmer
Bouton poussoir dimmable
Tastdimmer

CE IP20

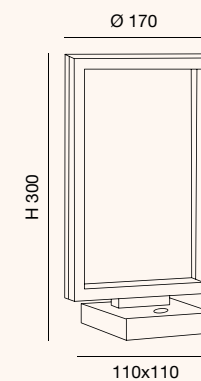

3775

Struttura in alluminio e metacrilato - Aluminium and methacrylate frame
 Monture en aluminium et métachrylate - Aluminium und Methacrylat

[See all collection](#)



table lamp



floor lamp p. 176



beba 3775

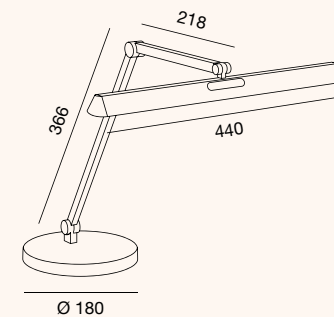

Blanc - Weiss Anthracite - Anthrazit

E LED WARM WHITE - COLD WHITE
 12W - 1340 lm

3775-30-102 Bianco - White

3775-30-282 Antracite - Anthracite

Regolazione luce al tocco
 Touch dimmer
 Variateur sensitif
 Touchdimmer

Orientabile - Adjustable
 Réglable - Schwenkbar

Warm white ↔ Cold white

CE IP20

See all collection

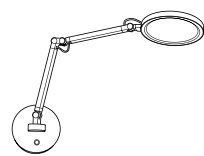

table lamp

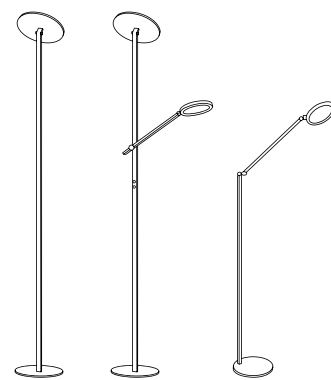

wall lamp p. 124



floor lamp p. 182

Noir - Schwarz  Blanc - Weiss 
Aluminium - Aluminium 



regina 3551

E LED WARM WHITE - COLD WHITE
9W - 1135 lm

3551-30-101  Nero - Black

3551-30-102  Bianco - White

3551-30-212  Alluminio - Aluminum

Regolazione luce al tocco
Touch dimmer
Variateur sensitif
Touchdimmer

 Orientabile - Adjustable
Réglable - Schwenkbar

 Warm white ↔ Cold white

CE  IP20

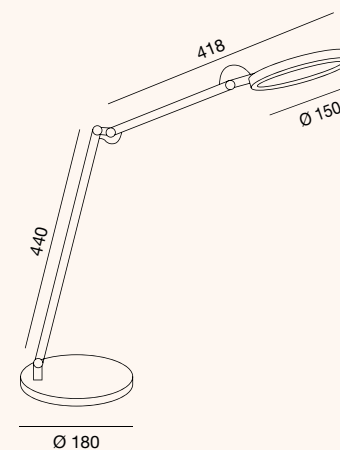

3550

Struttura in alluminio - Aluminum frame
Monture en aluminium - Aluminium

[See all collection](#)

table lamp

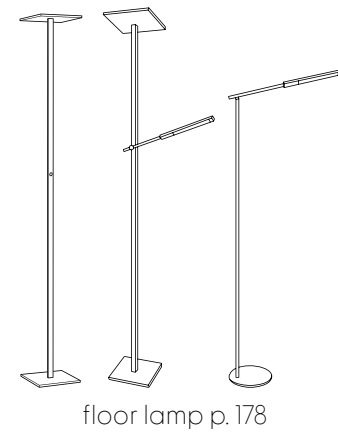

Noir - Schwarz Blanc - Weiss

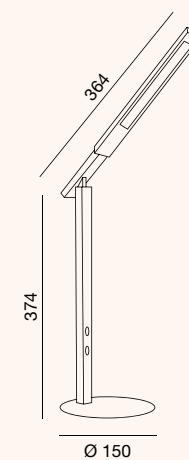

LED WARM WHITE - COLD WHITE
10W - 1000 lm

3550-30-101 Nero - Black

3550-30-102 Bianco - White

Regolazione luce al tocco
Touch dimmer
Variateur sensitif
Touchdimmer

Orientabile - Adjustable
Réglable - Schwenkbar

Warm white ↔ Cold white

CE IP20



floor lamp



[See all collection](#)



floor lamp

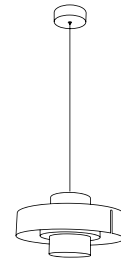

suspension p. 58

- Anthracite - Anthrazit
- Couleur sablé - Sandfarben
- Couleur brique - Ziegelfarbe

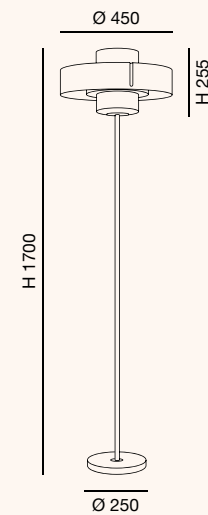

E27

1x40W

3750-10-282 Antracite - Anthracite

3750-10-355 Sabbia - Sand

3750-10-358 Mattone - Bricky

Con variatore - With dimmer
 Rechargeable - Mit dimmer

CE IP20

3775

Struttura in alluminio e metacrilato - Aluminium and methacrylate frame
 Monture en aluminium et métachrylate - Aluminium und Methacrylat

[See all collection](#)

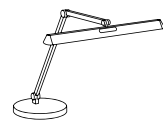
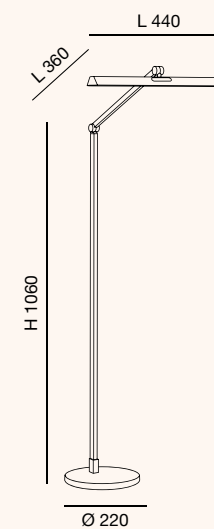

table lamp p. 166

floor lamp



Blanc - Weiss Anthracite - Anthrazit



E LED WARM WHITE - COLD WHITE
 12W - 1340 lm

3775-11-102 Bianco - White

3775-11-282 Antracite - Anthracite

Regolazione luce al tocco
 Touch dimmer
 Variateur sensitif
 Touchdimmer

Orientabile - Adjustable
 Réglable - Schwenkbar

Warm white ↔ Cold white

CE IP20

3550

Struttura in alluminio - Aluminum frame
Monture en aluminium - Aluminium

[See all collection](#)

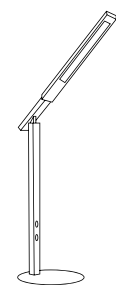

table lamp p. 170

floor lamp



Noir - Schwarz Blanc - Weiss



ideal 3550

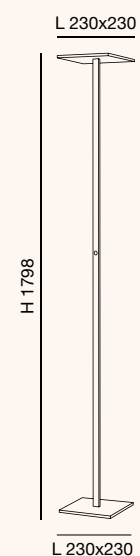

LED WARM WHITE - COLD WHITE
35W - 3500 lm

3550-12-101 Nero - Black

3550-12-102 Bianco - White

Regolazione luce al tocco
Touch dimmer
Variateur sensitif
Touchdimmer

Orientabile - Adjustable
Réglable - Schwenkbar

Warm white ↔ Cold white

CE IP20

Noir - Schwarz   Blanc - Weiss

Noir - Schwarz   Blanc - Weiss



floor lamp

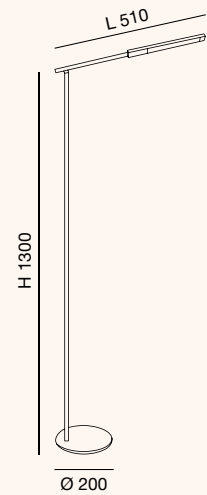



 **LED WARM WHITE - COLD WHITE**
10W - 1000 lm

3550-11-101  Nero - Black

3550-11-102  Bianco - White

 Regolazione luce al tocco
Touch dimmer
Variateur sensitif
Touchdimmer

 Orientabile - Adjustable
Réglable - Schwenkbar

 Warm white \leftrightarrow Cold white

CE   IP20

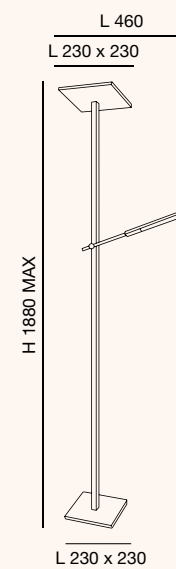

 **LED WARM WHITE**
40W+8W - 3050 + 670 lm

3550-10-101  Nero - Black

3550-10-102  Bianco - White

 Regolazione luce al tocco
Touch dimmer
Variateur sensitif
Touchdimmer

 Orientabile - Adjustable
Réglable - Schwenkbar

CE   IP20

3551

Struttura in metallo e metacrilato - Metal and methacrylate frame
 Monture en métal et métachrylate - Metall und Methacrylat

[See all collection](#)

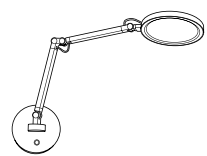



wall lamp p. 124



table lamp p. 168

floor lamp



Noir - Schwarz  Blanc - Weiss 



regina 3551





E LED WARM WHITE - COLD WHITE
 35W - 3500 lm

3551-12-101  Nero - Black

3551-12-102  Bianco - White

Regolazione luce al tocco
 Touch dimmer
 Variateur sensitif
 Touchdimmer

 Orientabile - Adjustable
 Réglable - Schwenkbar

 Warm white ↔ Cold white

CE  IP20

floor lamp



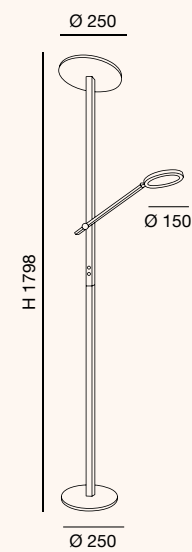

Noir - Schwarz  Blanc - Weiss 



 **LED WARM WHITE**
36W/12W - 3050 lm/1100 lm

3551-10-101  Nero - Black

3551-10-102  Bianco - White

 Regolazione luce al tocco
Touch dimmer
Variateur sensitif
Touchdimmer

 Orientabile - Adjustable
Réglable - Schwenkbar

CE   IP20

regina 3551

Noir - Schwarz   Blanc - Weiss
 Aluminium - Aluminium 

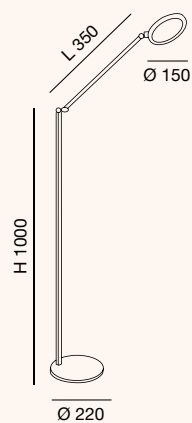

E LED WARM WHITE - COLD WHITE
 9W - 1135 lm

3551-11-101  Nero - Black

3551-11-102  Bianco - White

3551-11-212  Alluminio - Aluminum

Regolazione luce al tocco
 Touch dimmer
 Variateur sensitif
 Touchdimmer

 Orientabile - Adjustable
 Réglable - Schwenkbar

 Warm white ↔ Cold white

CE   IP20

floor lamp



regina 3551

3712

Struttura in metallo e metacrilato - Metal and methacrylate frame
 Monture en métal et métachrylate - Metall und Methacrylat

[See all collection](#)

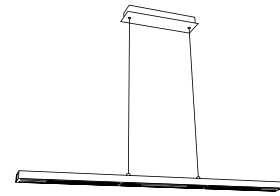

suspension p. 64

floor lamp



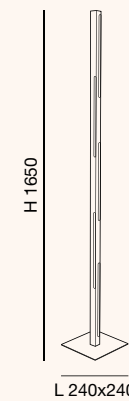

Noir - Schwarz  Laiton satiné - Messing satiniert 



LED WARM WHITE
 36W - 4320 lm

3712-10-101  Nero - Black

3712-10-119  Ottone satinato
 Satined brass

 Con variatore - With dimmer
 Avec variateur - Mit Dimmer

CE   IP20



portable lamp

armanda



Design s.t. Fabas Luce

3742

Struttura in metallo e policarbonato - Metal and polycarbonate frame
 Structure en métal et polycarbonate - Metall- und Polycarbonatstruktur



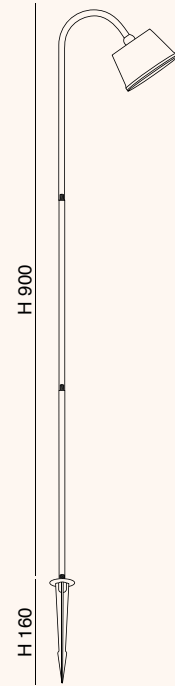

portable lamp

Noir - Schwarz   Blanc - Weiß
 Corten - Rostbraun 



LED WARM WHITE
 3W - 320 lm

3742-72-101  Nero - Black

3742-72-102  Bianco - White

3742-72-361  Corten - Rostbraun

Regolazione luce al tocco
 Touch dimmer
 Variateur sensitif
 Touchdimmer

 Orientabile - Adjustable
 Réglable - Schwenkbar

 Ricaricabile - Rechargeable
 Reéglable - Wiederaufladbar

CE  IP54

LED WARM WHITE
 3W - 320 lm

3742-50-101  Nero - Black

3742-50-102  Bianco - White

3742-50-361  Corten - Rostbraun

Regolazione luce al tocco
 Touch dimmer
 Variateur sensitif
 Touchdimmer



 Orientabile - Adjustable
 Réglable - Schwenkbar

 Ricaricabile - Rechargeable
 Reéglable - Wiederaufladbar

H 65 
 Ø 100

CE  IP54

armanda 3742

Noir - Schwarz   Blanc - Weiß
Corten - Rostbraun 





LED WARM WHITE
3W - 320 lm

3742-71-101  Nero - Black

3742-71-102  Bianco - White

3742-71-361  Corten - Rostbraun

 Regolazione luce al tocco
Touch dimmer
Variateur sensitif
Touchdimmer

 Orientabile - Adjustable
Réglable - Schwenkbar

 Ricaricabile - Rechargeable
Reéglable - Wiederaufladbar

CE  IP54

LED WARM WHITE
3W - 320 lm

3742-50-101  Nero - Black

3742-50-102  Bianco - White

3742-50-361  Corten - Rostbraun

 Regolazione luce al tocco
Touch dimmer
Variateur sensitif
Touchdimmer

 Orientabile - Adjustable
Réglable - Schwenkbar

 Ricaricabile - Rechargeable
Reéglable - Wiederaufladbar

CE  IP54

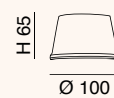
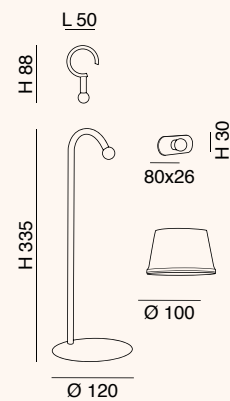



■ Noyer - Walnussfarben

portable lamp

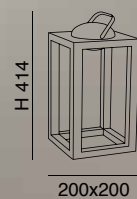

LED WARM WHITE
3W - 320 lm

3738-30-130 ■ Noce - Walnut

Regolazione luce al tocco
Touch dimmer
Variateur sensitif
Touchdimmer

Ricaricabile - Rechargeable
Reéglable - Wiederaufladbar

CE IP54

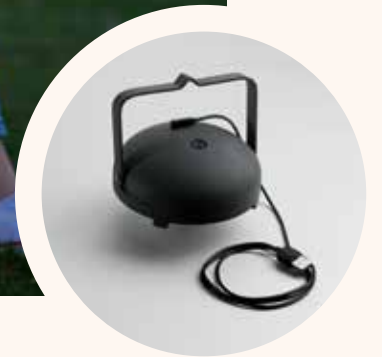

LED WARM WHITE
3W - 320 lm

3738-35-130 ■ Noce - Walnut

Regolazione luce al tocco
Touch dimmer
Variateur sensitif
Touchdimmer

Ricaricabile - Rechargeable
Reéglable - Wiederaufladbar

CE IP54

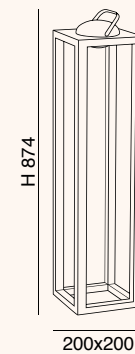

LED WARM WHITE
3W - 320 lm

3745-50-282 ■ Antracite - Anthracite

Regolazione luce al tocco
Touch dimmer
Variateur sensitif
Touchdimmer

Ricaricabile - Rechargeable
Reéglable - Wiederaufladbar

Illuminatore per tavolo
LED diffusor for table lamp
Diffuseur LED pour lampe de chevet
Nur LED-Moduleinheit für Tischleuchte

CE IP54

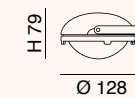



portable lamp



clamp 3741

LED WARM WHITE
3W - 320 lm

3741-30-130  Noce - Walnut

3741-30-132  Frassino - Ash wood

Regolazione luce al tocco
Touch dimmer
Variateur sensitif
Touchdimmer

Ricaricabile - Rechargeable
Reéglable - Wiederaufladbar

CE  IP54

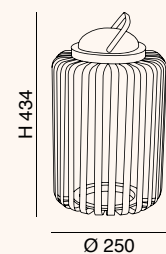

LED WARM WHITE
3W - 320 lm

3745-50-282  Antracite - Anthracite

Regolazione luce al tocco
Touch dimmer
Variateur sensitif
Touchdimmer

Ricaricabile - Rechargeable
Reéglable - Wiederaufladbar

Illuminatore per tavolo
LED diffuser for table lamp
Diffuseur LED pour lampe de chevet
Nur LED-Moduleinheit für Tischleuchte

CE  IP54

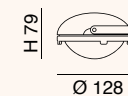

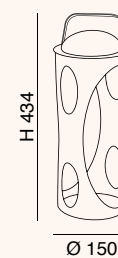

LED WARM WHITE
3W - 320 lm

3740-30-102 Bianco - White

3740-30-282 Antracite - Anthracite

Regolazione luce al tocco
Touch dimmer
Variateur sensitif
Touchdimmer

Ricaricabile - Rechargeable
Reéglable - Wiederaufladbar

CE IP54

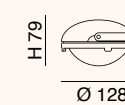

LED WARM WHITE
3W - 320 lm

3745-50-282 Antracite - Anthracite

Regolazione luce al tocco
Touch dimmer
Variateur sensitif
Touchdimmer

Ricaricabile - Rechargeable
Reéglable - Wiederaufladbar

illuminatore per tavolo
LED diffuseur for table lamp
Diffuseur LED pour lampe de chevet
Nur LED-Moduleinheit für Tischleuchte

CE IP54

indice per codice prodotto

Item code index

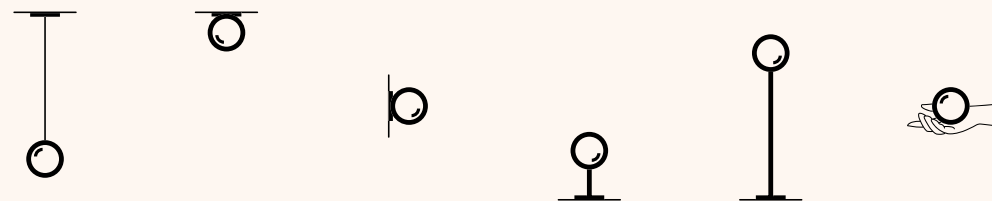

product code	product name	suspension pages	ceiling lamp pages	wall lamp pages	table lamp pages	floor lamp pages	portable lamp pages
3239	dunk	66		116			
3361	nala			130			
3394	bard	70	90	110	164		
3451	modo		104	138			
3481	lila	42					
3550	ideal				170	178	
3551	regina			124	168	182	
3618	banny			112			
3682	viki			118			
3685	prado	74					
3703	ibla				162		
3707	maribel			120			
3708	alide			122			
3709	relais		100				
3710	savoy		102				
3712	ling	64				188	
3715	roseg			126			
3717	dual			128			
3719	sinis			134			
3720	ago			136			
3738	blend						196
3740	caddy						200
3741	clamp						198
3742	armanda						192
3743	palau	60					
3750	loto	58				174	
3752	freddy				152		
3754	micky				158		
3755	brena	28					
3757	carola	14					
3758	cone	16					
3759	lisa	18					
3760	nadine				146		
3761	elea				160		
3762	wendy				148		
3763	wilma				150		
3764	lucille	54					
3767	kino	34	88				
3768	lapo	38					
3770	ariel	20			156		
3772	noa	48					
3774	deva	50					
3775	beba				166	176	
3783	victoria				154		
	imagine your light	76					

indice alfabetico

Alphabetical index



product name	product code	suspension pages	ceiling lamp pages	wall lamp pages	table lamp pages	floor lamp pages	portable lamp pages
ago	3720			136			
alide	3708			122			
ariel	3770	20			156		
armanda	3742						192
banny	3618			112			
bard	3394	70	90	110	164		
beba	3775				166	176	
blend	3738						196
brena	3755	28					
caddy	3740						200
carola	3757	14					
clamp	3741						198
cone	3758	16					
deva	3774	50					
dual	3717			128			
dunk	3239	66		116			
elea	3761				160		
freddy	3752				152		
ibla	3703				162		
ideal	3550				170	178	
imagine your light		76					
kino	3767	34	88				
lapo	3768	38					
lila	3481	42					
ling	3712	64				188	
lisa	3759	18					
loto	3750	58				174	
lucille	3764	54					
maribel	3707			120			
micky	3754				158		
modo	3451		104	138			
nadine	3760				146		
nala	3361			130			
noa	3772	48					
palau	3743	60					
prado	3685	74					
regina	3551			124	168	182	
relais	3709		100				
roseg	3715			126			
savoy	3710		102				
sinis	3719			134			
victoria	3783				154		
viki	3682			118			
wendy	3762				148		
wilma	3763				150		

Dimmerabile Dimmable Dimmbar	Dimmerabile a step Step dimmable Gradable In Stufen dimmbar	Dimmerazione a sensore Sensor dimming Capteur gradateur Sensordimmer	Regolazione luce al tocco Touch dimmer Variateur sensitif Touchdimmer
Accensione al tocco Touch switch Allumage tactile Tastschaltung	Regolazione luce con pulsante Push dimmer Bouton poussoir dimmable Tastdimmer	Con variatore With dimmer Rechargeable Mit Dimmer	Con interruttore With switch Avec interrupteur Mit Schalter
Con doppio interruttore With double lighting Avec double allumage Getrennt schaltbar	Orientabile Adjustable Réglable Schwenkbar	Ricaricabile Rechargeable Réglable Wiederaufladbare	Turn&lock
Warm white ← → Natural white	Bluetooth music speaker	Con telecomando With remote control Avec télécommande Mit Fernbedienung	Sensore di movimento Motion sensor Capteur de mouvement Bewegungssensor
USB charger	Gravity sensor	Bluetooth	Sensore ad infrarossi Infrared Sensor Capteur à infrarouge Infrarotsensor

- La dimmerazione funziona a taglio di fase: si raccomanda l'utilizzo di variatori compatibili. Alcune delle marche con prodotti compatibili sono: VARILIGHT, JUNG, BUSCH, AURORA, TCL
- The dimming function works on phase cut dimmers: we recommend appropriate dimmers. Some appropriate products are manufactured by the following: VARILIGHT, JUNG, BUSCH, AURORA, TCL
- La fonction de gradation fonctionne avec des variateurs à découpage de phase : nous recommandons d'utiliser des variateurs appropriés. Certains produits appropriés sont fabriqués par les sociétés suivantes: VARILIGHT, JUNG, BUSCH, AURORA, TCL
- Die Dimmfunktion arbeitet sowohl mit Phasenanschnittdimmer als auch mit Phasenabschnittdimmer. Wir empfehlen geeignete Dimmer zu verwenden. Hersteller einiger geeigneter Produkte sind: VARILIGHT, JUNG, BUSCH, AURORA, TCL

LAMPADINA INCLUSA / BULB INCLUDED
AMPOULE INCLUSE / LEUCHTMITTEL INKLUSIV

- E14
- GU10
- G9
- GX53
- LED

LAMPADINA ESCLUSA / BULB EXCLUDED
AMPOULE EXCLUE / LEUCHTMITTEL NICHT INKLUSIV

- E14
- GU10
- E27
- GX53



• Tutti i prodotti FABAS LUCE che rientrano nell'ambito di applicazione della direttiva europea compatibilità elettromagnetica E.M.C. 2014/30/UE e successive modifiche e/o della direttiva europea bassa tensione B.T. 2014/35/UE e successive modifiche, soddisfano i requisiti richiesti e recano la marcatura "CE".

• All FABAS LUCE products fall within the range of application of the European electromagnetic compatibility E.M.C.directive 2014/30/UE and subsequent amendment and/or the European low voltage directive B.T. 2014/35/UE and subsequent, meet the required specifications and bear "CE" labelling.

• Tous les produits FABAS LUCE appartenant au champ d'application de la directive européenne compatibilité électromagnétique E.M.C. 2014/30/UE et modifications successives et/ou de la directive européenne basse tension B.T. 2014/35/UE et modification successive remplissent les conditions prévues et portent le marquage "CE".

• Alle Produkte von FABAS LUCE, die unter das Anwendungsgebiet der europäischen Richtlinien der elektromagnetischen Kompatibilität E.M.C. 2014/30/UE und nachfolgende Änderungen und/oder der europäischen Richtlinie der Niederspannung B.T. 2014/35/UE und nachfolgende Änderung fallen, entsprechen den erforderlichen Eigenschaften und tragen den erforderlichen Eigenschaften und tragen das "CE" -Kennzeichen.



• Lampada la cui protezione contro la scarica elettrica non si basa solo sull'isolamento di base dell'apparecchio, ma su un ulteriore sistema di sicurezza che consiste nel collegamento dei componenti conduttivi accessibili ad un conduttore di sicurezza (messa a terra) facente parte dell'impianto elettrico.

• Luminaire in which protection against electrical shocks is not just based on the basic insulation but also on an additional safety precautions consisting of connecting the accessible conductive parts to a safety conductor (earth), that is included in the electrical system.

• L'appareil d'éclairage dans lequel la protection contre des chocs électriques n'est pas simplement basée sur l'isolation principale mais également sur des mesures de sécurité additionnelles en consistant à relier les parties conductrices accessibles à un conducteur de sûreté (la terre), celui inclus dans le système électrique.

• Leuchten in denen der Schutz gegen Stromschläge nicht nur auf der grundlegenden Isolierung basiert ist, sondern auch auf einer zusätzlichen Sicherheitsvorkehrung, bestehend aus den Anschluss der berührbaren leitfähigen Teile zu einem Schutzleiter (Erde), der in elektrischem System enthalten ist.



• Il simbolo indica la non idoneità degli apparecchi al montaggio diretto su superfici normalmente incombustibili. ATTENZIONE: l'apparecchio non può essere installato su superfici in legno o rivestite con tappezzeria. Se vengono installate lampadine LED o fluorescenza con potenza pari o inferiore a 20W l'apparecchio è da considerarsi IDONEO a essere installato su superfici normalmente incombustibili.

• The symbol indicates that the fixture is not suitable for assembly directly on normally inflammable surfaces. WARNING: the fixture can not be fixed on wall in wood or covered by wallpaper. If they are equipped with LED or fluorescent bulbs with power equal to or less than 20W the fixture is considered SUITABLE to be installed on flammable surfaces.

• Le symbole indique que cet Appareil ne doit pas être monté directement sur des surfaces normalement inflammables. ATTENTION: l'appareil ne doit pas être monté sur les surfaces revêtu de bois ou de tapisserie (surfaces normalement inflammables). S'il est équipé avec des ampoules LED ou fluorescents avec une puissance inférieure à ou égale à 20W l'appareil est considéré adapté pour être installé sur les surfaces inflammables.

• Die Leuchte ist nicht dazu geeignet, direkt auf normal entflammbaren Oberflächen installiert zu werden. ACHTUNG: das gerät kann nicht auf holz- oder mit tapetenpapier belegten oberflächen montiert werden. Bei Bestückung der Leuchte mit LED- oder Fluoreszenz-Leuchtmitteln mit einer Leistung von maximal 20 Watt kann das Gerät an entflammbaren Oberflächen montiert werden.



• Apparecchio in cui la protezione contro la scossa elettrica si basa sull'alimentazione a bassissima tensione di sicurezza (SELV) e in cui non si producono tensioni superiori alla stessa.

• A luminaire in which protection against electric shock relies on supply at safety extra-low voltage (SELV) and in which voltages higher than those of SELV are not generated.

• Un appareil d'éclairage dans lequel la protection contre la décharge électrique se fonde sur l'approvisionnement à la très-basse tension de sûreté (SELV) et dans quelles tensions plus haut que ceux de SELV ne sont pas produits.

• Eine Beleuchtung, in der Schutz gegen Elektroschock auf Versorgungsmaterial an der sehr-niedrigen Spannung der Sicherheit (SELV) beruht und in in welchen Spannungen höher, als die von SELV werden nicht erzeugt.



• Apparecchio omologato in classe II, con cablaggio a doppio isolamento. Durante l'installazione, tagliare il cavo di terra.

• Class II certified equipment, with double insulated wiring. During installation, cut earth wire.

• Appareil homologué en Classe II, avec câblage à double isolation. Pendant l'installation, couper le cable de terre.

• In Klasse II zugelassene Apparate mit doppelt isolierter Verkabelung. Während der Montage schneiden sie das Erdekabel.



• In caso di sostituzione della lampadina, utilizzarne una auto-protetta, che non necessita di schermo di protezione.

• In case of bulb replacement, use the auto-protected one, which doesn't need any other protection glass.

• Dans le cas du remplacement de l'ampoule, utiliser l'une auto-protégée, laquelle n'a pas besoin de autre verre de protection.

• Sollte die Birne ersetzt werden, die selbstbeschützende Birne benutzen, die kein weiteres Schutzglas braucht.

IP20

• Protetto contro corpi solidi maggiori di 12 mm.

• Protected against solid objects greater than 12 mm.

• Protégé contre les corps solides supérieur à 12 mm.

• Schutz vor dem Eindringen von Stoffen mit einem Durchmesser von mehr als 12 mm.

IP40

• Protetto contro corpi solidi maggiori di 1 mm.

• Protected against solid objects greater than 1 mm.

• Protégé contre les corps solides supérieur à 1 mm.

• Schutz vor dem Eindringen von Stoffen mit einem Durchmesser von mehr als 1 mm.

IP41

• Protetto contro corpi solidi maggiori di 1 mm e contro lo stilloccidio.

• Protected against solid objects greater than 1 mm and dripping water.

• Protégé contre les corps solides supérieurs à 1 mm et contre les chutes verticales de gouttes d'eau (condensation).

• Schutz vor dem Eindringen von Stoffen mit einem Durchmesser von mehr als 1 mm und vor dem Eindringen von Tropfen.

IP44

• Protetto contro corpi solidi maggiori di 1 mm e contro gli spruzzi.

• Protected against solid objects greater than 1 mm and splashing water.

• Protégé contre les corps solides supérieur à 1 mm et de giclées d'eau.

• Schutz vor dem Eindringen von Stoffen mit einem Durchmesser von mehr als 1 mm und vor dem Eindringen von Spritzwasser.

IP54

• Protetto contro la polvere e contro gli spruzzi.

• Protected against dust and splashing water.

• Protégé contre la poussière et de giclées d'eau.

• Geschützt gegen Staub und Spritzwasser.

IP65

• Totalmente protetto contro la polvere e i getti.

• Fully protected against dust and water jets.

• Totalemt protégé contre la poussière et jets d'eau.

• Komplett staubdicht und geschützt gegen Strahlwasser.

BASTA UNA PAROLA!

Lampade a controllo vocale

Gli assistenti vocali **Amazon Alexa** e **Google Home** sono ormai di uso comune nella gestione dell'illuminazione della casa e non solo. Le lampade a simbolo "Smartluce" che Fabas propone sono compatibili con l'utilizzo di alcune lampade a catalogo attraverso i comandi vocali che, interagendo attraverso la rete wi-fi, permettono di gestire la casa in modo smart e dinamico. **Cerca nel catalogo il simbolo Smartluce!**

ONE WORD IS ENOUGH!

Light voice control

The voice assistants **Amazon Alexa** and **Google Home** are commonly used in lighting home management and for many other functions. The Smartluce symbol lamps that Fabas offers are compatible through voice control which allows you to manage your home in a smart and dynamic way interacting through wi-fi networks. **Look for Smartluce symbol in the catalogue!**



SMARTLUCE INTEGRATO

Nelle pagine dove trovi il logo Smartluce integrato i prodotti possono essere già forniti con l'accessorio Smartluce. Per ordinare i prodotti con l'accessorio integrato dovrai semplicemente aggiungere in fondo al codice del prodotto scelto il suffisso "-01".

Ad esempio: qualora volessi ordinare la plafoniera BARD codice **3394-61-102**, con l'accessorio Smartluce integrato il codice diventa **3394-61-102-01**.

SMARTLUCE COMPATIBILE

Per le lampade che hanno il logo Smartluce compatibile occorre indicare nell'ordine il codice della lampada e separatamente il codice dell'accessorio sotto riportato:

3572-00-001

Accessorio dimmerabile nel caso di apparecchio dimmerabile

3572-00-002

Accessorio ON/OFF nel caso di apparecchio non dimmerabile

3572-00-006

Accessorio dimmerabile solo per art. **3508-45** e **3508-48**

PER LAMPADINE CON PORTALAMPADA E27 O G9

Con lampadine E27 o G9 non dimmerabili, utilizzare l'accessorio ON/OFF **3572-00-002**.

Con lampadine E27 o G9 dimmerabili, utilizzare obbligatoriamente l'accessorio **3572-00-001**.

Il corretto funzionamento della dimmerabilità è dipendente dalla qualità dell'elettronica contenuta nella lampadina.

PERCHÈ SCEGLIERE SMARTLUCE?

Caratteristiche

1. Le nostre lampade "SMARTLUCE" sono progettate per parlare direttamente con la tua rete wi-fi attraverso l'intelligenza artificiale delle piattaforme AMAZON o GOOGLE.
2. Non hanno bisogno di accessori o gateway.
3. Non hanno bisogno di bridge o di altri accessori per controllare via assistente vocale le nostre lampade.
4. Non servono telecomandi o app per controllare le lampade.
5. Puoi controllare le nostre lampade dal tuo smartphone attraverso internet anche quando sei lontano da casa.

Funzionalità

1. Si può utilizzare normalmente l'interruttore di accensione/spengimento.
2. Si può cambiare l'intensità luminosa, accendere e spegnere attraverso la app SMARTLUCE Fabas disponibile per ANDROID/IOS.
3. Si può dimmerare, accendere e spegnere le proprie luci attraverso il sito web www.smartluce.com da qualunque parte del mondo.
4. Si può controllare le lampade dagli assistenti vocali GOOGLE HOME e ALEXA senza bisogno di Gateway.

Possibilità di utilizzo

1. Accendere una lampada o tutte le lampade.
2. Variare l'intensità della luce della lampada.
3. Programmare vari scenari, ad esempio momenti diversi della giornata.
4. Controllare gruppi di lampade.
5. Gestire la lampada Fabas insieme ad un ecosistema di altri prodotti e produttori (lampade, prese, eccetera).
6. Non servono telecomandi dedicati o app per controllare le lampade.



INTEGRATED SMARTLUCE

When you find the integrated Smartluce logo it means that the products may have the built-in accessory. To order products with the integrated accessory, just enter the product code chosen with the suffix "-01".

For example: should you wish to order the BARD ceiling lamp code **3394-61-102**, with the integrated Smartluce accessory the code becomes **3394-61-102-01**.

COMPATIBLE SMARTLUCE

Should you wish to order lamps that have the compatible Smartluce logo you must indicate in the order the code number of the lamp and the code of Smartluce accessory separately by using the code below:

3572-00-001

Dimmable accessory in case of dimmable lighting

3572-00-002

ON/OFF accessory in case of non-dimmable lighting

3572-00-006

Dimmable accessory only for item **3508-45** and **3508-48**

FOR LAMPS WITH E27 OR G9 LAMP HOLDERS

With not dimmable E27 or G9 bulbs, use our accessory ON/OFF **3572-00-002**.

With dimmable E27 or G9 bulbs, it is mandatory to use our accessory **3572-00-001**.

Be aware that a correct functionality of dimming depends on electronics quality contained in the bulb.

WHY CHOOSE SMARTLUCE?

Features "Smartluce"

1. Our "SMART LUCE" lamps are engineered to speak directly with your wi-fi network through the artificial intelligence of AMAZON or GOOGLE platforms.
2. They do not need accessories or gateways.
3. They do not need bridge or other accessories to control our lamps via voice assistant.
4. No remote controls or apps are required to control the lamps.
5. You can control our lamps from your smartphone through internet even when you are away from home.

Functions

1. On/off switch installed in your house can be normally used.
2. Dimming, switch on and off the light through SMARTLUCE Fabas App available for ANDROID/IOS.
3. Dimming, turning on and off your lights through www.smartluce.com website from anywhere in the world.
4. Control the lamp lighting from GOOGLE HOME and ALEXA voice assistants without needing a Gateway.

How to use

1. Turn on a lamp or all lamps.
2. Dimming the lamp lighting.
3. Program different scenarios, for example different moments of the day.
4. Control and manage groups of lamps.
5. Manage Fabas lamp together with an ecosystem of other products and producers (lamps, sockets, etc.).
6. No need for remote or apps to control the lamps.

ATTENZIONE:

Tutti i prodotti Fabas Luce sono registrati e protetti da brevetto; le contraffazioni saranno perseguibili giuridicamente. Il luogo d'adempimento e il foro competente è in entrambi i casi Monza (Italia). In linea di massima valgono solo le nostre condizioni di vendita e di consegna. Ci riserviamo il diritto di proprietà su questo catalogo. La consegna è franco fabbrica. Tutte le misure indicate nel presente catalogo sono in millimetri. L'azienda si riserva, ferme restando le caratteristiche basilari del prodotto, di apportare senza preavviso tutte le modifiche che riterrà necessarie allo scopo di migliorare la qualità del prodotto stesso.

Lampadine:

Sono comprese nella consegna se nella descrizione del prodotto è dichiarato in modo esplicito che sono incluse (incl.). Le lampadine sono considerate beni di consumo e per questo non sono soggette ai diritti di garanzia altrimenti validi.

Pezzi di ricambio:

Sono consultabili sul sito www.fabasluce.it.

Cura del prodotto:

Per la pulizia delle lampade utilizzare soltanto uno straccio di cotone morbido asciutto. Non utilizzare detergenti e liquidi. Fare inoltre attenzione alle istruzioni di utilizzo e di assemblaggio consegnate assieme alla lampada. Ci riserviamo il diritto di apportare modifiche di progettazione. Le specifiche sulle misure fanno riferimento a misurazioni approssimative.

Riserva di proprietà:

Ci riserviamo la proprietà sulle merci fornite fino al pagamento completo di tutti i crediti derivanti dal contratto di fornitura. Questo vale anche per le consegne future, anche se non sempre ne viene fatto riferimento esplicito. Siamo legittimati a riprenderci la merce qualora il committente violi il contratto.

PLEASE NOTE:

Fabas Luce products are protected by design registrations and patents, imitations will be prosecuted. Place of delivery and jurisdiction for both parties is Monza (Italy). As a rule, only our sales and supply conditions will be applied. We reserve ownership rights to this catalogue. Delivery is ex works. All dimensions in this catalogue are in millimeters. While maintaining the basic characteristics of the product, the manufacturer reserves the right to make modifications at any time and without any prior notice, with the sole aim of improving the quality of the product.

Bulbs:

Included in delivery only if declared as included (incl.) in product specifications. Bulbs are consumables and thus not subject to otherwise applicable defect warranty rights.

Spareparts:

Are accessible on the website www.fabasluce.it.

Care information:

Please only use a soft dry cotton cloth to clean the lamps. Please do not use cleaners or liquids. Please also read the instructions of use and assembly supplied with the lamps. We reserve the right to design modifications. The measurement specifications refer to approximate dimensions.

Retention of title:

We reserve ownership rights of the delivered goods until complete payment of all receivables resulting from the contract. These conditions also apply to all future business relations even if this is not expressly agreed again. We are entitled to take back the goods if the buyer breaches the contract.

NOTEZ S'IL VOUS PLAÎT:

Les produits Fabas Luce sont protégés par le dépôt de dessins et de brevets, les imitations seront poursuivies. Le lieu de la compétence juridique pour les deux parties est Monza (Italie). En règle générale, seules nos conditions de vente et d'approvisionnement sont applicables. Nous nous réservons le droit de propriété de ce catalogue. La livraison est départ-usine (EXW). Toutes les dimensions de ce catalogue sont en millimètres. La société se réserve le droit, sous réserve de conserver les caractéristiques de base du produit, de procéder sans préavis, à toutes modifications qui seraient nécessaires, dans le but d'améliorer la qualité du produit.

Ampoules:

Seulement incluses dans la livraison, s'il est spécifié qu'elles sont incluses (incl.) dans le produit. Les ampoules sont des consommables et ne sont donc pas soumises au droit de garantie.

Pièces de rechange:

Sont accessibles sur le site web www.fabasluce.it.

Entretien informations:

S'il vous plaît utilisez uniquement un chiffon de coton doux et sec pour nettoyer les lampes. S'il vous plaît ne pas utiliser des nettoyeurs ou des liquides. S'il vous plaît lisez les instructions d'utilisation et de montage fournies avec les lampes. Nous nous réservons le droit d'apporter des modifications sur les produits. Les informations de mesure se réfèrent à des dimensions approximatives.

Réserve de propriété:

Nous nous réservons le droit de propriété des marchandises livrées jusqu'au paiement intégral de toutes les créances résultant du contrat. Ces conditions sont également applicables à toutes les relations commerciales futures, même si cela n'avait pas été expressément convenu. Nous sommes en droit de reprendre la marchandise si l'acheteur ne respecte pas le contrat.

BITTE BEACHTEN SIE:

Alle Fabas Luce Leuchtenmodelle sind als Geschmacksmuster geschützt, Nachahmungen werden gerichtlich verfolgt. Erfüllungsort und Gerichtsstand für beide Teile ist Monza (Italien). Es gelten grundsätzlich nur unsere Verkaufs- und Lieferbedingungen. Das Eigentumsrecht dieses Kataloges behalten wir uns vor. Lieferung erfolgt ab Fabrik. Alle Maße in diesem Katalog sind in Millimeter. Unter Beibehaltung der grundlegenden Produkteigenschaften behält sich der Hersteller das Recht vor, die Änderungen jederzeit und ohne vorherige Ankündigung vorzunehmen, mit dem einzigen Ziel der Qualitätsverbesserung des Produkts.

Leuchtmittel:

gehören nur dann zum Lieferumfang, wenn diese in den Produktbeschreibungen ausdrücklich als inklusive (incl.) gekennzeichnet sind. Bitte beachten Sie, dass Leuchtmittel Verbrauchsgüter sind und nicht den ansonsten gültigen Sachmängelansprüchen unterliegen.

Ersatzteile:

Können direkt auf der Webseite www.fabasluce.it angeschaut werden.

Pflegehinweis:

Für die Leuchtenpflege bitte nur ein weiches trockenes Baumwolltuch benutzen. Bitte keine Reinigungsmittel und Flüssigkeiten verwenden. Bitte beachten Sie zusätzlich die der Leuchte beigefügten Gebrauchs- und Montageanleitungen. Konstruktionsänderungen behalten wir uns vor. Bei der Maßangaben handelt es sich um ca.-Abmessungen.

Eigentumsvorbehalt:

Wir behalten uns das Eigentum an der gelieferten Sache bis zur vollständigen Bezahlung sämtlicher Forderungen aus dem Liefervertrag vor. Dies gilt auch für alle zukünftigen Lieferungen, auch wenn wir uns nicht stets ausdrücklich hierauf berufen. Wir sind berechtigt, die Kaufsache zurückzunehmen, wenn der Besteller sich vertragswidrig verhält.

FABAS LUCE S.p.A.
sede

Via Luigi Talamoni, 75
20861 Brugherio (MB) Italy
Tel. 0039 039 890 69 1
0039 039 214 22 06
Fax 0039 039 214 22 08
www.fabasluce.it
info@fabasluce.it
venditefabas@fabasluce.it
salesdept@fabasluce.it



FABAS LUCE GmbH

Westring, 5
D-59759 Arnsberg Germany
Tel. 0049 29 32 / 8 90 16 60
Fax 0049 29 32 / 8 90 16 62
vertrieb@fabasluce.com



© DITRE IDEAS MAKERS

graphic artwork & photo editing
Ditre.com

photo
Quasarfoto.com
Unsplash.com

Pages: 1-2-4-14-17-18-20-23-25-26-31-36-38-41
48-57-93-94-96-110-116-138-141-142-146-150
152-155-156-159-160-164-166-172-174-182-192

printed in Italy
July 2023

È VIETATA LA RIPRODUZIONE ANCHE
PARZIALE DI QUESTO CATALOGO.
IT IS FORBIDDEN TO REPRODUCE
ANY PART OF THIS CATALOGUE.



CAF2023-05



8 019282 549031

www.fabasluc.it